



BROSCO's Commercial Shop includes fully licensed Warnock-Hersey, Inc./Intertek Testing Services (WHI/ITS) labeling services for Wood Doors and Hollow Metal Products. BROSCO's "State-of-the-art" wood door machining equipment provides the capability to meet all of your architectural and commercial door requirements.

State-of-the-Art Shop
Warnock-Hersey Licensed
Full Line of Inventory
Dedicated Inside Sales Group
Complete Packages Available
Special Orders



TABLE OF CONTENTS

Fire Door Suggested Procedures.....	AC-2
Quote Request Form.....	AC-3
JELD-WEN Solid Core Doors	AC-4
Commercial Wood Door Frames.....	AC-4
MOHAWK Commercial Flush Doors	AC-5
Wood Door Machining Price List.....	AC-6
Metal Edges and Astragals	AC-6
Door Machining Order Form	AC-7
TIMELY Steel Frames	AC-8
TIMELY Frame Machining Specs.....	AC-9
AMWELD Specifications	AC-10
AMWELD Hollow Metal Frames Price List.....	AC-11
AMWELD Specs Machining Price List	AC-12
AMWELD Hollow Metal Doors Price List	AC-13
AMWELD Tilt'N Place Prehung Door Units.....	AC-14
Finishing Instructions - Flush Door & Timely Frame	AC-15
Vision Inserts.....	AC-16
Louver Inserts	AC-17
HAGER Hinges	AC-18
HAGER Door Closers	AC-18
LCN & DOR-O-MATIC Door Closers	AC-19
SCHLAGE Door Locks.....	AC-20
HAGER Door Locks	AC-21
HAGER Exit Devices.....	AC-22
VON DUPRIN Exit Devices.....	AC-23
Public Access Thresholds	AC-24
Door Accessories	AC-24
Weatherstripping, Seals & Sweeps.....	AC-25
ELMDOR Access Doors.....	AC-26
ADA Compliant Secondary Railing.....	AC-27
BRADLEY Washroom Accessories	AC-28 & 29
BRADLEY • MILLS Washroom Partitions	AC-30 & 31



Anemostat



Bradley®

- A. Determine the appropriate building code.
- B. Check and fulfill the fire insurance company's requirements for the specific building.
- C. Basic Fire Door Requirements - Use this check list.
 1. A fire door must have a label attached.
 2. A fire door frame must have either an attached or an embossed label.
 3. A fire door must be self-latching.
 4. A fire door must be self-closing.
 5. If a fire door is held open, it must be equipped with a listed heat responsive device, fusible link or smoke detection device.
 6. A fire door must be free of any obstructions which could prevent the door from operating properly, i.e., wedge door stops, chain, hook-backs, etc.
 7. Only listed fire door hardware shall be used.
 8. A fire door must have steel bearing type hinges. (Exception: Non bearing plain steel hinges may be used if they are part of a listed assembly.)
 9. Doors swinging in pairs that require astragals shall have at least one overlapping astragal. Pairs of doors within a means of egress shall not be equipped with an astragal that inhibits the free use of either leaf. A coordinator or open back strike should be used to ensure proper closing.
10. Fire doors with glass lights:
 - a. The glass frame and glazing bead must be metal.
 - b. The glass must be labeled wire glass not less than 1/4" thick or as permitted by the labeling agency.
 - c. Maximum allowable glass area:
 - 3-hour A label - no glass permitted.
 - 1 1/2-hour B label - 100 sq. in. per door leaf
 - 3/4-hour C label - 1296 sq. in. per light
 - 1 1/2-hour D label - no glass permitted.
 - 3/4-hour E label - 1296 sq. in. per light
 - 1/3-hour - 1296 sq. in. per light.
11. Fire doors with fusible link louvers (not allowed in 20-Minute Doors):
 - a. Only listed louvers may be used.
 - b. Louvers may be furnished in 1 3/4" thick doors with a 1 1/2-hour B label or a 3/4-hour C label (no louver and glass light combinations are permitted.)
 - c. Maximum louver size is 24" x 24".
 - d. Louvers are not permitted to be installed in doors with Fire Exit Hardware or in stairwells.
- D. For maximum fire protection Standard number 80 of the National Fire Protection Association should be used for an installation guide.
- E. Purchase doors from BROSCO, a recognized responsible manufacturer/distributor, whose fire doors and frames are produced to conform to Fire Door Procedures and are subject to periodic inspections.

ARCHITECTURAL DOOR HANDING

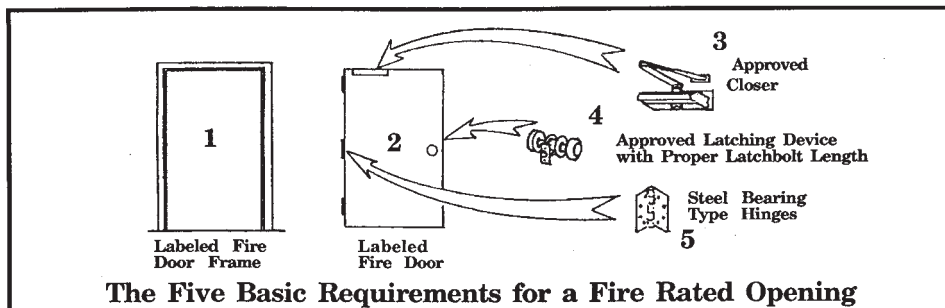
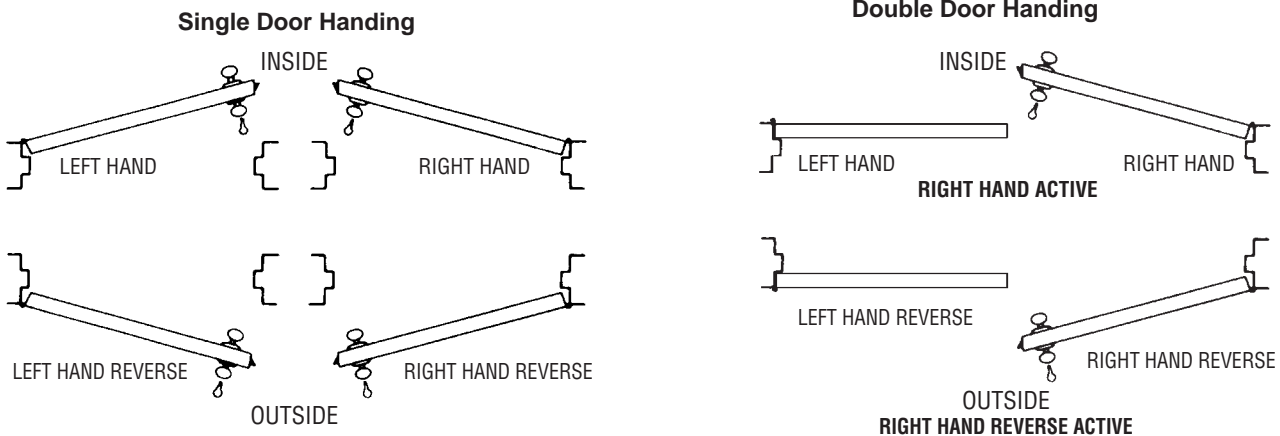



DOOR FEATURES:

- Good Grade
- Construction: 9-Ply
- Loose lay up core (non-bonded)
- Warranty - Interior Use - Five Year (standard)

For Fir or Moulded 20 Minute Doors –
See Tab W

For Infinity, Encore or Bravo 20 Minute Doors –
See Tab MDF

DOOR SIZE	ProCore (Solid Core) - 20 Minute			Wood Block Core*	
	#300 Lauan	#300 Birch	#300 Oak	#400 Birch	#400 Oak
	Softwood Edge Strips w/Fiber Rails		Hardwood Edge Strips w/Fiber Rails	Hardwood Edge Strips w/Wood Rails	
2'-0" x 6'-8" x 1 3/4"	\$104.00	\$107.00	\$156.00	–	–
2'-4"	104.00	111.00	167.00	–	–
2'-6"	116.00	124.00	176.00	\$287.00	–
2'-8"	121.00	130.00	185.00	294.00	–
2'-10"	–	140.00	196.00	–	\$312.00
3'-0"	131.00	140.00	210.00	303.00	322.00
3'-6"	–	315.00 ♣	–	437.00	–
2'-0" x 7'-0" x 1 3/4"	115.00	122.00	–	–	–
2'-2"	119.00	126.00	–	–	–
2'-4"	119.00	126.00	–	–	–
2'-6"	131.00	139.00	191.00	–	–
2'-8"	135.00	144.00	200.00	–	–
2'-10"	145.00	155.00	–	–	327.00
3'-0"	145.00	155.00	210.00	319.00	337.00
3'-4"	–	329.00 ♣	–	–	–
3'-6"	–	329.00 ♣	–	–	–
4'-0"	–	339.00 ♣	–	–	–

SET-UP INTERIOR WOOD FRAMES
add to the price of a door only up to and including 3'-0" x 7'-0"

For Set-up 20 Minute Door
(includes door and frame label)
ADD \$167.00

For Set-up Solid Core Door - No Label
ADD \$161.00

Features:
Door: † Fully machined (161 prep)
Frame: Clear Pine 4 7/8" Single Rabbeted
Hinges: NOT INCLUDED (see below)

Rough Opening:
ADD 2 1/2" to Door Width and Door Height

OPTIONAL EXTRAS (Clear Pine Frames)

20 MINUTE FIRE RATED – Not available in pairs		NON-FIRE RATED –	
7 1/4" Single Rabbet 20 Minute Jamb	ADD \$98.00	4 5/8" Single Rabbet Jamb	DEDUCT -\$8.00
Rip Jamb to specified Width (minimum 3 3/4") ★	ADD 25.00	6 9/16" Single Rabbet Jamb	ADD 30.00
2'-0" & 2'-4" width frame	ADD 26.00	7 1/4" Single Rabbet Jamb	ADD 98.00
3'-4" x 7'-0" Unit (specify Jamb Width)	ADD 60.00	Rip Jamb down to specified Width	ADD 25.00
3'-6" x 7'-0" Unit (specify Jamb Width)	ADD 60.00	2'-0" & 2'-4" width frame	ADD 26.00
4'-0" x 7'-0" Unit not available		3'-6" x 7'-0" Unit (specify Jamb Width)	ADD 21.00

Note: Water-based painted multi-face skins could show flitch separations.

CONSULT LOCAL CODES ON REQUIREMENTS FOR REQUIRED FIRE RATED OPENINGS

ALL FIRE LABELED DOORS (20 minute) MUST BE MACHINED BY BROSCO

- NOTES:**
- † Includes prefit, 3° Bevel 1 side, (3) 4 1/2" x 4 1/2" Hinge Prep (BROSCO spec.)
 - ★ If specified width is between 4 15/16" and 7 3/16", you must also add for 7 1/4" jamb option.
 - ♣ Hardwood Edge Strips w/Fiber Rails
 - * Not Fire Rated.



Architectural/Commercial

1³/₄" MOHAWK FLUSH DOORS



FEATURES:

- Premium Grade
- Edge-bonded Construction (Type I Adhesive)
- Compatible Stiles with Birch Doors
- Matching Stiles with Oak Doors
- Interior Use - Only
- **All Doors are Prefit**
 - Undersized 3/16" width - 1/8" bevel, one edge
 - Undersized 5/8" height

Commercial Series –

Limited Lifetime Warranty (Standard)

Size	PREMIUM BIRCH (Rotary Cut) - DOOR ONLY						6-PANEL MOULDED DOOR ONLY (SMOOTH)	
	Commercial Series						Primed	
	BIRCH – Unfinished			BIRCH – Prefinished "Clear"				
	Particle Core/ 20 Minute	Mineral Core/ 45/60 Minute	Mineral Core/ 90 Minute	Particle Core/ 20 Minute	Mineral Core/ 45/60 Minute	Mineral Core/ 90 Minute	Particle Core/ 20 Minute	Mineral Core/ 60 Minute
2'-0" x 6'-8"	\$158.00	–	–	–	–	–	–	–
2'-4"	169.00	–	–	–	–	–	–	–
2'-6"	169.00	\$328.00	\$381.00	–	–	–	–	–
2'-8"	176.00	334.00	387.00	\$206.00	–	–	\$172.00	\$366.00
3'-0"	184.00	338.00	392.00	214.00	\$368.00	\$422.00	180.00	372.00
2'-0" x 7'-0"	180.00	–	–	–	–	–	–	–
2'-4"	180.00	–	–	–	–	–	–	–
2'-6"	180.00	340.00	–	–	–	–	–	–
2'-8"	184.00	348.00	403.00	214.00	–	–	183.00	378.00
3'-0"	195.00	354.00	409.00	225.00	384.00	439.00	191.00	393.00
3'-6"	260.00	–	530.00	290.00	–	–	–	–
4'-0"	280.00	–	536.00	–	–	–	–	–
3'-0" x 8'-0"	253.00	–	477.00	–	–	–	–	–
4'-0"	324.00	–	–	–	–	–	–	–

When Birch Door Skins are to be field painted, request one piece face veneer (non-stock, additional charge - please inquire). Water-based painted multi-face skins will show flitch separations which are not considered a defect and will not be replaced.

Size	PREMIUM OAK (Plain Sliced) - DOOR ONLY			
	Commercial Series			
	OAK – Unfinished		OAK – Prefinished "Clear"	
	Particle Core/ 20 Minute	Mineral Core/ 90 Minute	Particle Core/ 20 Minute	Mineral Core/ 90 Minute
2'-6" x 6'-8"	\$211.00	\$424.00	\$241.00	–
2'-8"	218.00	429.00	248.00	–
3'-0"	227.00	433.00	257.00	\$463.00
2'-6" x 7'-0"	222.00	433.00	252.00	–
2'-8"	227.00	442.00	257.00	–
3'-0"	236.00	448.00	266.00	478.00
3'-6"	278.00	–	–	–
4'-0"	296.00	582.00	326.00	–
3'-0" x 8'-0"	267.00	–	–	–
4'-0"	372.00	–	–	–

ALL FIRE LABELED DOORS (20, 45, 60, 90 minute) MUST BE MACHINED

**Machine and
161 Prep
Cylindrical
\$31.00**

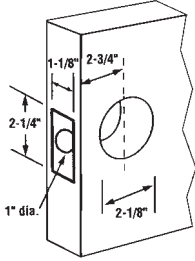

**Machine and
161 Prep w/Thru Bolts
Cylindrical
\$38.00**

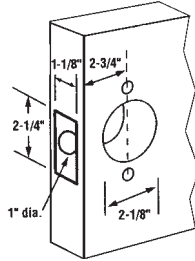

**Machine and
Mortise Pocket
Only
\$65.00**

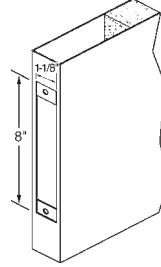

**Machine and
Mortise Pocket
w/Function Holes
\$87.00**

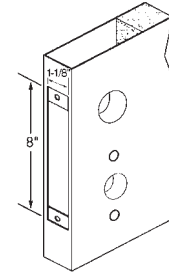

For function holes,
template must be
supplied.

ADD for Fire Door Label 20/45/60/90	\$ 6.00
Machine Door - No Bore	18.00

**Machine includes: Bevel 1-side and Hinge prep for three 4 1/2" x 4 1/2" Hinges.
Fire Rated doors must be machined at BROSCO.**

Hinge & Pivot Prep –

4th Hinge	\$17.00
5" Hinges	17.00
Extra Depth for Heavy Weight Hinge	21.00
Pivot Hinge Prep (per pivot)	65.00
Double Acting Hinge Prep	87.00
Concealed Hinge Prep (per hinge)	65.00
Size for Hollow Metal Frame	21.00

Lock Preps –

Mortise Deadbolt Prep Pocket Only	\$42.00
Deadbolt Prep Only	15.00
Machine Door for Rim Exit Device	65.00
Machine Door for Surface Mount Vert. Rod	65.00
Concealed Prep Closer (non-rated doors only)	65.00
Prep Mortise Door Bottom	43.00

Reduce Door Width

PC/20	\$ 85.00
45/60/90	155.00

Reduce Door Height

PC/20	\$55.00
45/60/90	90.00

Door Cut-out Only –

Half Glass	\$25.00
Full Glass	37.00

Miscellaneous –

Roller Latch	\$ 38.00
Peep Hole Prep Only	13.00
ADD for Electric Raceway	87.00
Sight Match Pair of Doors	15.00
Dutch Door Prep - No Shelf	157.00
ADD for Dutch Door Shelf w/Brackets	
Birch	187.00
Oak	187.00

Metal Edges and Astragals

Required on all Fire Rated Pairs of Wood Doors

Use with Vertical Rod

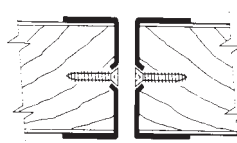

ME 90

Pair Metal Edge only
6'-8" or 7'-0" ht. (no prep)

\$115.00

Use with ASA & Flush Bolt

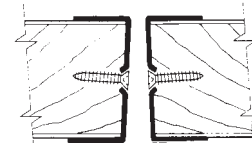

MEA

Pair Metal Edges and Astragal
6'-8" or 7'-0" ht.

for Swinging Doors (no prep)

\$120.00

ASA and Flush Bolt Prep only

\$49.00



Architectural/Commercial DOOR MACHINING ORDER FORM



DEALER	P.O. NUMBER	JOB NAME	REQUIRED DELIVERY DATE

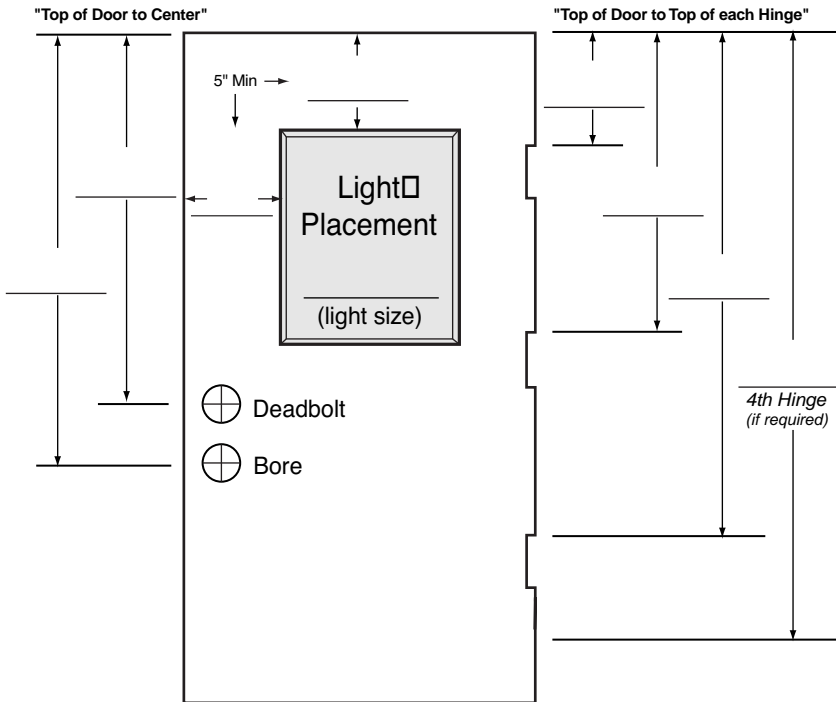

MORTISE LOCK
(Template must be supplied)

TOP OF DOOR TO TOP OF FACEPLATE	MANUFACTURER NO.	
<input type="text"/>	<input type="text"/>	
	SERIES NO.	
<input type="text"/>	<input type="text"/>	
POCKET WIDTH	POCKET DEPTH	POCKET LENGTH
<input type="text"/>	<input type="text"/>	<input type="text"/>
FACEPLATE WIDTH	FACEPLATE DEPTH	CORNER RADIUS
<input type="text"/>	<input type="text"/>	<input type="text"/>

Door Type: _____ *Net Width: _____ Net Height: _____

- | | | | |
|---|--|--|---|
| Fire Label:
<input type="checkbox"/> 90 Min.
<input type="checkbox"/> 60 Min.
<input type="checkbox"/> 45 Min.
<input type="checkbox"/> 20 Min.
<input type="checkbox"/> None | Standard Specs:
<input type="checkbox"/> Amweld
<input type="checkbox"/> Ceco
<input type="checkbox"/> Curries
<input type="checkbox"/> Fleming
<input type="checkbox"/> Pioneer
<input type="checkbox"/> Republic
<input type="checkbox"/> Timely
<input type="checkbox"/> Other _____ | Door Handing:
<input type="checkbox"/> Left Hand
<input type="checkbox"/> Right Hand
<input type="checkbox"/> Left Hand Reverse
<input type="checkbox"/> Right Hand Reverse | Hinge Specs:
<input type="checkbox"/> 4 1/2" Square or Radius
<input type="checkbox"/> Other _____ |
| Inactive Leaf Prep:
<input type="checkbox"/> Flush Bolt
<input type="checkbox"/> ASA Prep | <input type="checkbox"/> Other _____ | Lock Backset:
<input type="checkbox"/> 2 3/8"
<input type="checkbox"/> 2 3/4"
<input type="checkbox"/> Other _____ | Hinge Depth:
<input type="checkbox"/> Standard .134
<input type="checkbox"/> Other _____ |

Comments: _____

Customer Signature: _____

Date: _____

CONSULT LOCAL CODES ON REQUIREMENTS FOR FIRE RATED OPENINGS

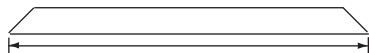

* Note: Some doors have beveled edges. The wide side should be measured for net door width.

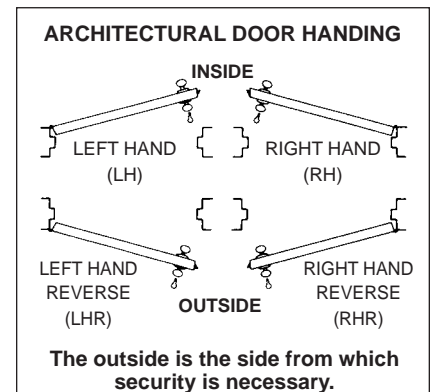

NOTES: Additional lead time may be required. Templates must be provided when necessary.
 All stock doors are prefit 3/16" in width and 5/8" in height with 3° bevel (1 side).

Timely frames are solidly anchored every 11 inches, directly into wood or metal studs. This method provides a level of structural integrity unmatched by free-standing hollow metal door frames.

Features of a Timely K.D. Steel Frame Only:

- Easy to install, no shimming needed
 - Timely Steel Frames must always be installed **with** a door.
- Frame wall sizes range from 3³/₄" to 7³/₈"
- Snap on steel casing is standard. Other casing available including wood casing.
- 6'-8" frames are reversible
- Double rabbet profile
- "S" Series Frames: 20 gauge steel
"C" Series Frames: 18 gauge steel
"A" Series Frames: 18 gauge steel
- 14 gauge hinge reinforcements
- Hinges, Sill and Strike Plate not included

FOR
INTERIOR USE
ONLY

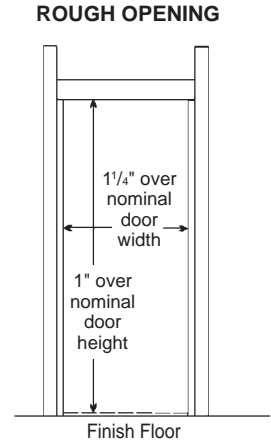

PREFINISHED STEEL FRAMES ONLY								
K.D. Frame prepped for: (3) 4 ¹ / ₂ " Square Corner Hinges and ASA Strike Plate (not included)	45 "S" 4 ⁵ / ₈ " Wall	47 "S" 4 ⁷ / ₈ " Wall	65 "C" 6 ⁵ / ₈ " Wall	67 "C" 6 ⁷ / ₈ " Wall	54 "A" Adjustable 3 ³ / ₄ " to 5 ⁹ / ₁₆ " Walls	Adjustable 3 ³ / ₄ " to 5 ⁹ / ₁₆ " Walls	73 "A" Adjustable 5 ¹¹ / ₁₆ " to 7 ³ / ₈ " Walls	Adjustable 5 ¹¹ / ₁₆ " to 7 ³ / ₈ " Walls
	Western White		Western White		Western White	PRIMED ♣	Western White	PRIMED ♣
2'-0" x 6'-8"	\$166.00 ☆	\$173.00 ☆	\$274.00 ☆	\$275.00 ☆	-	-	-	-
2'-4"	166.00 ☆	173.00 ☆	274.00 ☆	275.00 ☆	-	-	-	-
2'-6"	139.00	147.00	274.00 ☆	275.00 ☆	\$250.00	-	\$265.00	-
2'-8"	139.00	147.00	274.00 ☆	275.00 ☆	250.00	-	265.00	-
3'-0"	139.00	147.00	248.00	249.00	250.00	\$219.00	265.00	\$231.00
3'-6"	173.00 ☆	181.00 ☆	347.00 ☆	344.00 ☆	250.00	-	265.00	-
5'-0"	190.00 ☆	289.00 ☆	396.00	400.00	-	-	-	-
5'-4"	190.00 ☆	289.00 ☆	396.00	400.00	-	-	-	-
6'-0"	164.00	263.00	396.00	400.00	288.00	-	305.00	-
2'-0" x 7'-0"	178.00 ☆	184.00 ☆	290.00 ☆	292.00 ☆	-	-	-	-
2'-4"	178.00 ☆	184.00 ☆	290.00 ☆	292.00 ☆	-	-	-	-
2'-6"	151.00	158.00	290.00 ☆	292.00 ☆	265.00	-	280.00	-
2'-8"	151.00	158.00	290.00 ☆	292.00 ☆	265.00	-	280.00	-
3'-0"	151.00	158.00	264.00	266.00	265.00	315.00	280.00	327.00
3'-6"	185.00 ☆	192.00 ☆	363.00 ☆	361.00 ☆	265.00	-	280.00	-
5'-0"	278.00 ☆	353.00 ☆	411.00	415.00	-	-	-	-
5'-4"	278.00 ☆	353.00 ☆	411.00	415.00	-	-	-	-
6'-0"	252.00	327.00	411.00	415.00	-	-	-	-
* 3'-0" x 8'-0"	-	255.00	-	-	-	-	-	-

K.D. FRAME ONLY OPTIONS:

- TA-10 Closer Reinforcement Bracket (required in labeled opening) - regular arm ADD **\$10.00**
- TA-12 Closer Reinforcement Sleeve (required in labeled opening) - parallel arm ADD **19.00**
- Prep Frame only for Deadbolt Strike Plate ADD **25.00**
- Fire Label - 90 Minute Label (cannot be field applied) ADD **6.00**
- No Casing (TA-8)..... ADD **6.00**
- 16oz. Spray Can Touch-up Paint for Frame ADD **17.00**
- ASA Strike Fill Plate (gray) ADD **5.00**

20 ft. pkg Self Adhesive Silicone Gasket (specify charcoal or white)..... ADD **29.00**
- Perimeter Seal is required to be field applied (by others) for a 20-Minute Opening.

♣ Steel Casing not available with Primed Frames.

NOTES: K.D. Timely frames are shipped in 2 cartons – one carton includes the head jamb and head casing, the other carton includes the side jambs and side casing.

* 8-0 High frames prepped for four (4) Hinges.

☆ Price includes cut and splice charge (allow additional shop time).

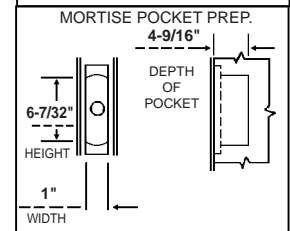
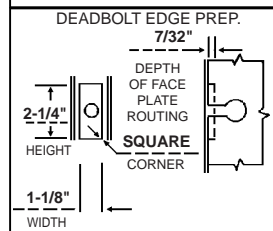
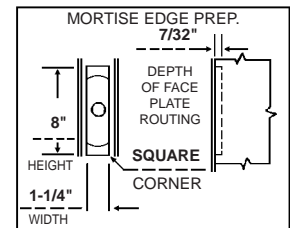
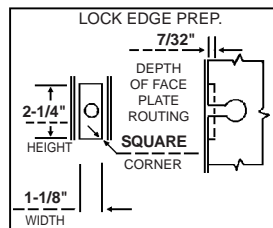
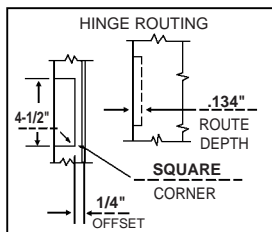
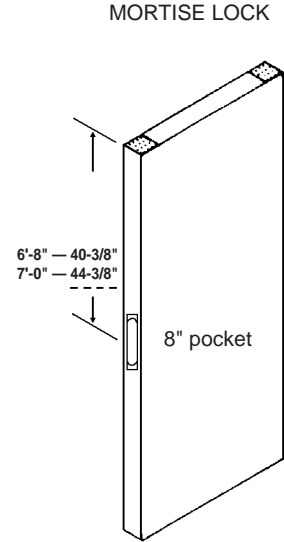
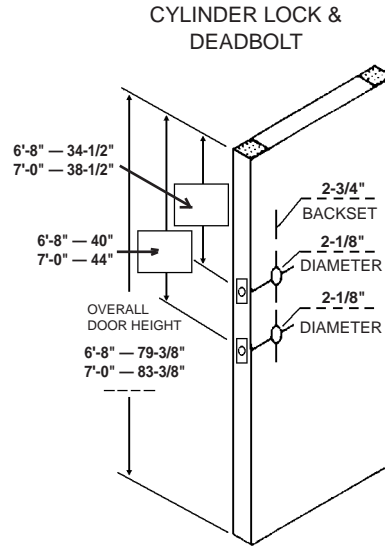
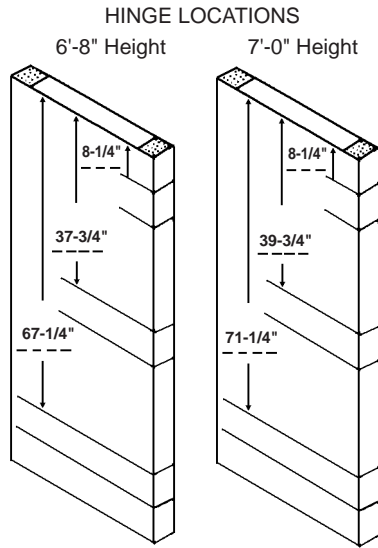

VISION LIGHT & LOUVER CUT-OUT

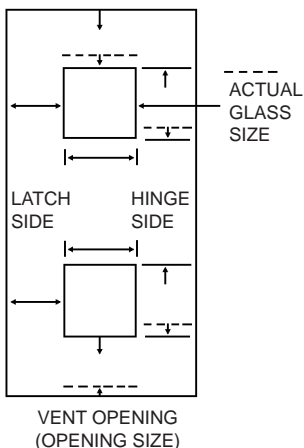

VISION INSERTS:

- * 5 x 35 - Top of light is 6" in from lock stile and 6" down from top of door.
- * 6 x 27, 7 x 22 - Center of light is 60" up from bottom of door and 6" in from lock stile.
- * 12 x 12 - Center of light is 60" up from bottom of door and centered in width of door.
- ¥ 24 x 30, 24 x 32 - Top of light is 6" down from top of door and centered in width of door.

* Maximum 100 square inches for 60 and 90 minute fire rated doors.
 ¥ Maximum 1296 square inches for 20 and 45 minute fire rated doors.

LOUVERS:

All - Bottom of louver is 12" up from bottom of door and centered in width of door.

HARDWARE LOCATIONS ON AMWELD FRAMES

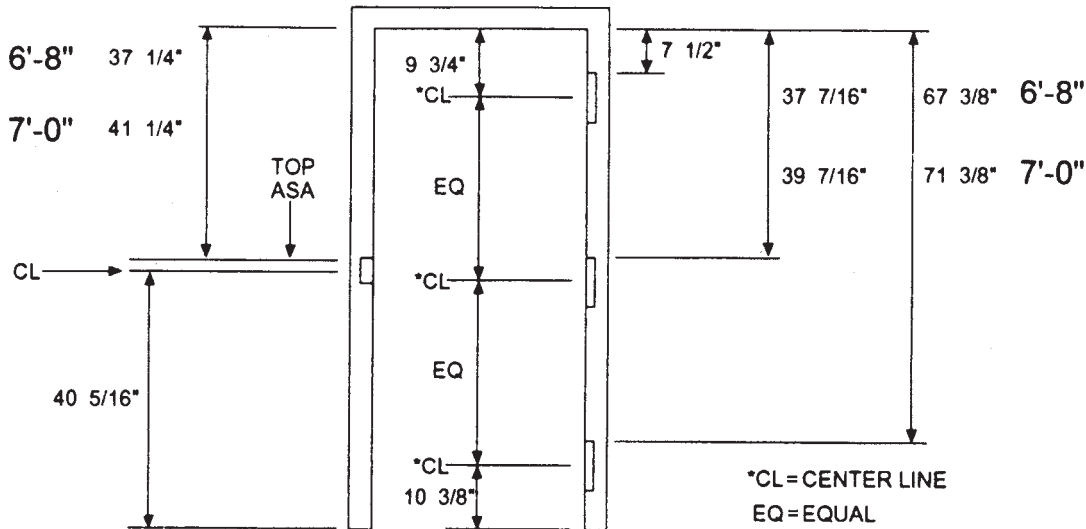

STANDARD PREPARATION

3 - 4 1/2" Std. Wt. Hinges
1 - ASA Strike (1 1/4" x 4 7/8")

HINGE SPACING HINGE BACKSET

6'-8" 29 15/16" 5/16"
7'-0" 31 15/16"

FRAME INFORMATION —

- FRAME TYPE:** MASONRY - 16 gauge cold rolled or galvanized steel
DRYWALL - 16 gauge standard
- FRAME SIZE:** Provide jamb opening width x jamb opening height
- ANCHOR TYPE:** All frames on estimating sheet are priced with anchor. (Additional pricing for "Existing Wall" Anchors)
- LABEL:** When labeled frames are required, advise rating.
- HEADS:** 2" Face is standard (see rough opening formulas)
4" Face can be furnished for standard masonry frames
Heads furnished less closer reinforcement, unless specified.
- SPECIAL REQUIREMENTS:** Please specify or submit drawing.
- CUSTOM FRAMES:** Available on special order.

**Rough Opening: add 4 1/2" to door width
add 2 1/4" to door height**

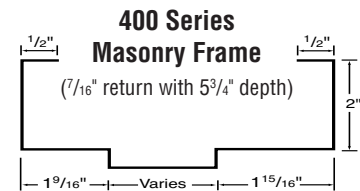

**Rough Opening: add 2" to door width
add 1" to door height**

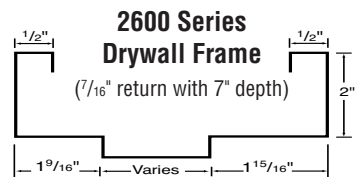

**Rough Opening: add 2" to door width
add 1" to door height**

DOOR INFORMATION —

- NOMINAL SIZE:** Width and Height.
- NET DOOR SIZE:** 1/4" less than nominal width
7/8" less than nominal height
- STOCK DOORS:** Available with 161 prep, 86 edge prep, blank, or blank with reinforcement for rim panic hardware.
- LABEL REQUIREMENTS:** Specify when required for use with Fire Exit Hardware.
- CLOSER REINFORCEMENT:** All doors are closer reinforced.
- CUSTOM DOORS:** Available on special order.
Specify sizes, gauge, hardware type and locations.
Templates required.





Architectural/Commercial HOLLOW METAL FRAMES



MASONRY K.D. FRAMES for 1-3/4" Doors							
JAMB OPENING	16 GAUGE						
	400 Series Standard Frames					Dbl Egress	Galvanized
	Throat Opening ▶	3-3/4"	4-7/8"	5-3/4"	6-3/4"	7-3/4"	4-3/4"
Frame Size ▶	4-3/4"	5-3/4"	6-3/4"	7-3/4"	8-3/4"	5-3/4"	5-3/4"
2068	\$179.00 ☆	\$128.00	\$191.00 ☆	\$209.00 ☆	\$213.00 ☆	-	\$203.00 ☆
2468	179.00 ☆	128.00	191.00 ☆	209.00 ☆	213.00 ☆	-	203.00 ☆
2668	179.00 ☆	128.00	191.00 ☆	209.00 ☆	213.00 ☆	-	203.00 ☆
2868	179.00 ☆	128.00	191.00 ☆	209.00 ☆	213.00 ☆	-	203.00 ☆
3068	132.00	128.00	144.00	162.00	166.00	-	156.00
3468	205.00 ☆	180.00 ☆	217.00 ☆	233.00 ☆	219.00 ☆	-	242.00 ☆
3668	205.00 ☆	133.00	217.00 ☆	233.00 ☆	172.00	-	242.00 ☆
3868	205.00 ☆	180.00 ☆	217.00 ☆	233.00 ☆	219.00 ☆	-	242.00 ☆
4068	205.00 ☆	133.00	217.00 ☆	233.00 ☆	172.00	-	242.00 ☆
5068 ♦	213.00 ☆	161.00	225.00 ☆	241.00 ☆	246.00 ☆	\$488.00	250.00 ☆
5468 ♦	213.00 ☆	208.00 ☆	225.00 ☆	241.00 ☆	246.00 ☆	488.00	277.00 ☆
6068 ♦	166.00	161.00	178.00	194.00	199.00	488.00	203.00
8068 ♦	289.00 ☆	176.00	304.00 ☆	328.00 ☆	199.00	488.00	304.00 ☆
2070	193.00 ☆	142.00	205.00 ☆	223.00 ☆	227.00 ☆	-	217.00 ☆
2470	193.00 ☆	142.00	205.00 ☆	223.00 ☆	227.00 ☆	-	217.00 ☆
2670	193.00 ☆	142.00	205.00 ☆	223.00 ☆	227.00 ☆	-	217.00 ☆
2870	193.00 ☆	142.00	205.00 ☆	223.00 ☆	227.00 ☆	-	217.00 ☆
3070	146.00	142.00	158.00	176.00	180.00	-	170.00
3470	219.00 ☆	194.00 ☆	231.00 ☆	247.00 ☆	233.00 ☆	-	256.00 ☆
3670	219.00 ☆	147.00	231.00 ☆	247.00 ☆	186.00	-	256.00 ☆
3870	219.00 ☆	194.00 ☆	231.00 ☆	247.00 ☆	233.00 ☆	-	256.00 ☆
4070	219.00 ☆	147.00	231.00 ☆	247.00 ☆	186.00	-	256.00 ☆
5070 ♦	175.00	175.00	239.00 ☆	254.00 ☆	260.00 ☆	488.00	264.00 ☆
5470 ♦	222.00 ☆	222.00 ☆	239.00 ☆	254.00 ☆	260.00 ☆	488.00	264.00 ☆
6070 ♦	180.00	175.00	192.00	207.00	213.00	488.00	217.00
8070 ♦	303.00 ☆	190.00	318.00 ☆	341.00 ☆	346.00 ☆	488.00	345.00 ☆
3080	-	157.00	Call for Pricing ☎			-	399.00
4080	-	162.00	Call for Pricing ☎			-	485.00
6080 ♦	-	189.00	Call for Pricing ☎			-	512.00
8080 ♦	-	204.00	Call for Pricing ☎			-	640.00

DRYWALL K.D. FRAMES for 1-3/4" Doors – OVERALL Jamb Depth									
JAMB OPENING	2600 Series Standard Frames (16 Gauge)						4600 Series Trimmed Opening		
	Throat Opening ▶	4-5/8"	4-7/8"	5-1/4"	6-1/8"	6-3/4"	7-1/4"	4-5/8"	4-7/8"
	Frame Size ▶	5-5/8"	5-7/8"	6-1/4"	7-1/8"	Galv. 7-3/4"	8-1/4"	5-5/8"	5-7/8"
2068 ■	\$144.00	\$144.00	\$204.00 ☆	\$204.00 ☆	\$234.00 ☆	\$229.00 ☆	\$224.00 ☆	\$224.00 ☆	
2468 ■	144.00	144.00	204.00 ☆	204.00 ☆	234.00 ☆	229.00 ☆	224.00 ☆	224.00 ☆	
2668 ■	144.00	144.00	204.00 ☆	204.00 ☆	187.00	229.00 ☆	224.00 ☆	224.00 ☆	
2868 ■	144.00	144.00	204.00 ☆	204.00 ☆	187.00	229.00 ☆	224.00 ☆	224.00 ☆	
3068 ■	144.00	144.00	157.00	157.00	187.00	182.00	177.00	177.00	
3668 ■	196.00	196.00	230.00	230.00	189.00	135.00	249.00	249.00	
4068 ■	149.00	149.00	230.00 ☆	230.00 ☆	189.00	188.00	249.00 ☆	249.00 ☆	
5068 ♦	177.00	177.00	236.00 ☆	238.00 ☆	217.00	261.00 ☆	249.00 ☆	249.00 ☆	
6068 ♦	177.00	177.00	189.00	191.00	217.00	214.00	202.00	202.00	
2070	153.00	153.00	212.00 ☆	212.00 ☆	243.00 ☆	237.00 ☆	193.00 ☆	193.00 ☆	
2470	153.00	153.00	212.00 ☆	212.00 ☆	243.00 ☆	237.00 ☆	193.00 ☆	193.00 ☆	
2670	153.00	153.00	212.00 ☆	212.00 ☆	196.00	237.00 ☆	193.00 ☆	193.00 ☆	
2870	153.00	153.00	212.00 ☆	212.00 ☆	196.00	237.00 ☆	193.00 ☆	193.00 ☆	
3070	153.00	153.00	165.00	165.00	196.00	190.00	146.00	146.00	
3670	205.00 ☆	205.00 ☆	238.00 ☆	238.00 ☆	198.00	243.00	218.00 ☆	218.00 ☆	
4070	158.00	158.00	238.00 ☆	238.00 ☆	245.00 ☆	196.00 ☆	218.00 ☆	218.00 ☆	
5070 ♦	186.00	186.00	245.00 ☆	247.00 ☆	225.00	270.00 ☆	218.00 ☆	218.00 ☆	
6070 ♦	186.00	186.00	198.00	200.00	225.00	223.00	171.00	171.00	

NOTES: ☆ Price includes cut and splice charge (allow additional shop time).
 ■ Standard 3- 4 1/2 x 4 1/2 Hinges and ASA Strike Plate
 ♦ Pricing based on Double door frame.
 Contact your BROSCO office for availability of Heads with 4" Face.

List
 For WHI/ITS Label - ADD \$ 6.00
 Set-Up and Weld Frame -
 Single ADD 42.00
 Double ADD 50.00
 Prep Frame for EWA (w/bolts) - ADD 58.00

Hollow Metal FRAME Shop Services	
	LIST
Splice Header	\$ 44.00
Cut Frame Height at Bottom (5" Maximum)	33.00
Prep for Deadbolt	39.00
Prep for ASA Strike	39.00
Prep for 5" Hinge (each)	39.00
Prep for Flush Bolt Strike	42.00
Prep for Electric Strike ASA	69.00
Prep for Electric Strike non-ASA	70.00
Prep for "H" Type Lock Thimble	57.00
Prep for "H" Type Lock Strike	60.00
Prep for Heavy Weight Hinge (each)	40.00
Prep for EWA w/Bolts (8 each)	58.00
Prep for Dutch Door	146.00
Prep Masonry Frame for Drywall	45.00
Reinforce for Rim Exit Device	16.00
Reinforce for Vertical Rod Exit Device	17.00
Prep Frame Leg for Elaison Door	42.00
Prep Frame Leg for 3 Double Acting Hinges	70.00
Weld Frames (single)	42.00
Weld in Frame Closer Reinforcement (single)	17.00

Hollow Metal DOOR Shop Services	
	LIST
Cut Door for Half Glass or Smaller	\$ 59.00
Cut Door for Full Glass	82.00
Install Glass Light in Door	27.00
Cut Door in Height (one cut)	111.00
Weld on Astragal	22.00
Prep Door Edge for Strike (No Astragal)	66.00
Prep for Deadbolt	60.00
Prep for 161 Prep	62.00
Prep for 86 Edge	70.00
Prep Door for Hinge (each)	73.00
Prep Door Edge for ASA and F/B	151.00
Prep Door Edge for ASA and F/B Holes (Astragal req.)	100.00
Prep for Rim Exit Device	52.00
Prep for Vertical Rod Exit Device	50.00
Prep for Thru Bolts (lock)	22.00
Prep for "H" Lock	100.00
Prep for Mortise Lock Function Holes	53.00
Prep for Heavy Weight Hinge (each)	30.00
Prep for Dutch Door (no shelf)	236.00
Filler Plate 161 or 86 Edge (applied)	26.00
Blank Door 161 Edge	91.00

AMWELD FAB-A-FRAME STANDARD 16 GAUGE SIDELIGHT FRAMES

Glazing bead provided / Glass by others.

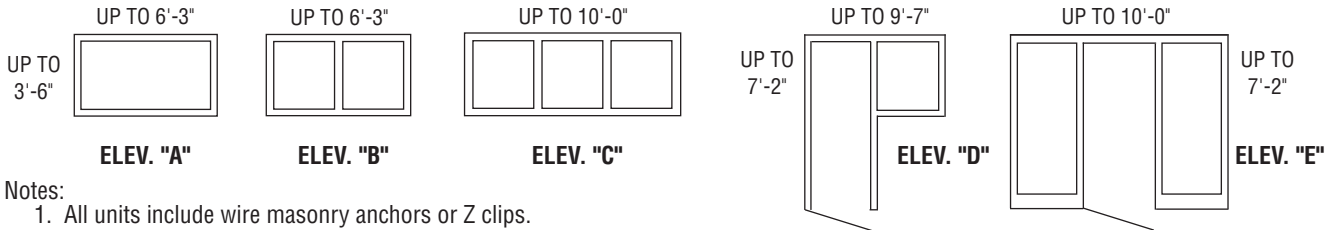

Notes:

1. All units include wire masonry anchors or Z clips.
2. Other jamb depths available.
3. WHI/ITS - Fire rated units available. **Call for a quote.**
4. Sidelights also available.
5. Specify Anchor Types.

SET-UP and WELDED – Call for Quote.

Stock Jamb Depths: 5³/₄", 6³/₄", 7³/₄", 8³/₄"

ACCESSORIES AND PARTS LIST - Anchors

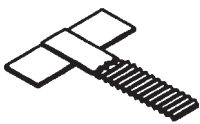

Masonry Anchor
\$2.70
4³/₄" – #14100-01
5³/₄" – #14102-01
6³/₄" – #01429-05
7³/₄" – #01429-09
8³/₄" – #01429-06



Masonry Wire Anchor
Adjustable to all sizes
(#01497-00)
\$.70

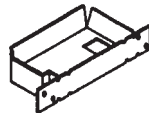

Wood Stud Anchor - 4³/₄"
(#14104-00)
\$1.90

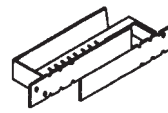

Adjustable Wood Stud Anchor - 5³/₄"
(#14107-00)
\$1.40

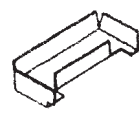

Channel Steel Stud Anchor - 5³/₄"
(#14117-01)
\$1.50



Drywall Sill Anchor - (4¹/₂" to 8¹/₄")
(#14601-01)
\$.70
Must be welded-in

Completed Opening Anchor consisting of:

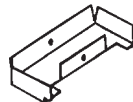

Bracket - 6³/₄", 7³/₄", 8³/₄"
(#14194-02)
\$1.40



Hole Plug
(#14195-00)
\$.30

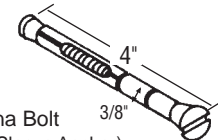

Dyna Bolt (Flat Head Sleeve Anchor)
(#14161-02)
\$1.40

Amweld Hollow Metal Doors are constructed using a Polystyrene Core - making them strong, quiet and 25% more energy-efficient than paper honeycomb core doors.

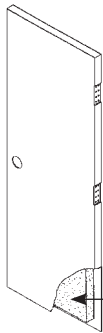

Exclusive Laser Edge Technology

15 LE Series Flush
18 gauge

25 LE Series Flush
18 gauge • Hot-Dipped Galvanized (.04)

Polystyrene Core

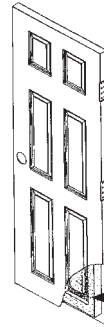

6100 Series 6-Panel Embossed
18 gauge
Hot-Dipped Galvanized (.04)

Polystyrene Core

Doors are Undersized
1/4" Width
3/4" Height

Nominal Size	161	86 Edge	Push/Pull Blank	ASA & FB w/Astragal	Reinforced for Exit Hardware
Liberty Series Full Flush - 18 Gauge					
3068	\$324.00	-	-	-	-
3070	333.00	-	-	-	-
15 LE Series Full Flush - 18 Gauge					
2068	\$346.00	-	-	-	-
2468	376.00	-	-	-	-
2668	385.00	-	-	\$512.00	-
2868	389.00	-	-	-	-
21068	392.00	-	-	-	-
3068	392.00	\$392.00	-	519.00	\$419.00
3468	437.00	-	-	-	-
3668	456.00	-	-	-	484.00
3868	472.00	-	-	-	-
4068	509.00	-	-	-	-
2070	364.00	-	-	-	-
2470	394.00	-	-	-	-
2670	403.00	-	-	530.00	-
2870	407.00	-	-	-	-
21070	410.00	-	-	-	-
3070	410.00	410.00	-	537.00	437.00
3470	455.00	-	-	-	-
3670	475.00	-	-	-	-
3870	490.00	-	-	-	-
4070	528.00	-	-	-	-
3080	553.00	-	-	-	-
4080	672.00	-	-	-	-
★ 15 LE Series - 18 Gauge (No Hinge or Hardware Prep)					
3068	-	-	\$392.00	-	-
3070	-	-	409.00	-	-

Nominal Size	161	86 Edge	ASA & FB w/Astragal	Reinforced for Exit Hardware
25 LE Series Full Flush - 18 Gauge (Galvanized)				
3068	\$439.00	-	-	\$469.00
3070	457.00	\$457.00	-	488.00
6100 Series 6-Panel Embossed - 18 Gauge (Galvanized)				
2668	\$394.00	-	-	-
2868	389.00	-	-	-
3068	392.00	-	\$507.00	\$423.00
3468	435.00	-	-	-
3668	473.00	-	-	-
2670	405.00	-	-	-
2870	400.00	-	-	-
3070	417.00	-	519.00	434.00
3470	448.00	-	-	-
3670	485.00	-	-	-

For WH/ITS Label - ADD \$6.00 List

ASTRAGALS	
DESCRIPTION	LIST PRICE
Flat Bar Astragal 8'-0"	\$31.00
<u>Wrap Astragals:</u>	
6'-8" ASA and FB - Rev.	66.00
7'-0" ASA and FB - LH	66.00
7'-0" ASA and FB - RH	66.00
8'-0" ASA and FB - LH	69.00
8'-0" ASA and FB - RH	69.00
8'-0" Blank - LH	42.00
8'-0" Blank - RH	42.00

AMWELD BORE OPTIONS

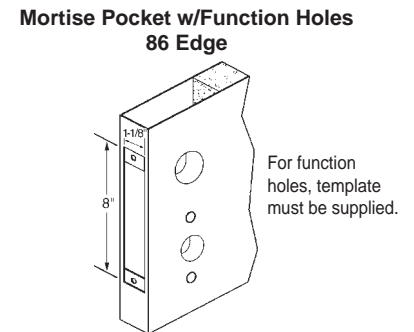
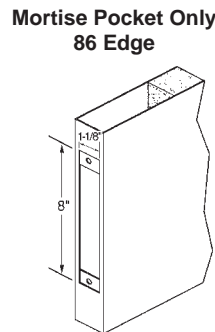
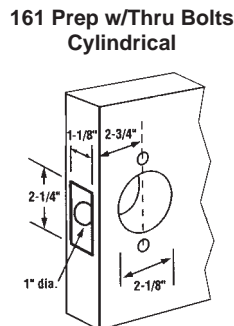
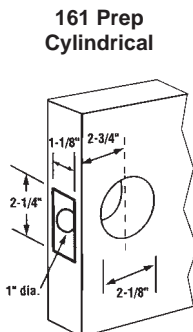

NOTES: ★ Not reinforced. Not Labeled. Cannot be used in a labeled application. Contact your BROSCO office for sizes not listed.

Tilt 'N Place

DOOR SYSTEMS BY AMWELD INTERNATIONAL™

Complete Commercial Opening In One Box
18 gauge Flush Doors Installed in Set-Up Frame

Size	LH/RHR	RH/LHR
3'-0" x 6'-8" 1 ³ / ₄ "	\$711.00	\$711.00
3'-0" x 7'-0" 1 ³ / ₄ "	736.00	736.00

90-Minute Rated
Opening



Each Boxed Door Unit Includes:

- Tilt'N Place Frame – 16 gauge Steel Split Jamb, Welded Frame, Primed
- Liberty 18 gauge Steel Door – Primed, 161 Lock Prep
- Hinges (3 each 4¹/₂" x 4¹/₂" Brushed Chrome) Installed
- Attachment Screws
- Installation Instructions
- Door and Frame are Closer Reinforced
- Fits Walls 4⁵/₈" through 5" Thick
- Rough Opening: add 2" to door width, 1" to door height
- 90-Minute UL Fire Label

- EACH BOX INCLUDES:**
- Tilt'N Place Frame
 - Door
 - Hinges (already installed)
 - Installation Instructions
 - Attachment Screws
- TOOLS REQUIRED:**
- Level
 - Screw Gun with P2 Bit
 - P2 Screwdriver
 - Bar Clamp or Similar Clamp that has Non-Marring Pads

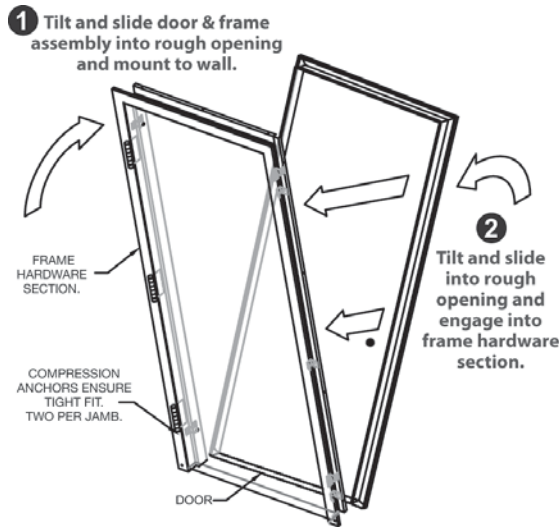

Steel doors are prime-painted and have a flush top cap and 12 gauge closer reinforcement.



The inverted bottom channel allows for easy trim adjustment if necessary, for a perfect fit.

Each Frame Is Adjustable To Multiple Wall Thicknesses.

For alternate sizes, wall thickness or door styles of Tilt'N Place units, Please Contact BROSCO Commercial Sales Department.

Recommendations on how to store, handle, finish and install Mohawk Flush Doors.

Storing

- Store flat on level surface in a clean, dry, well-ventilated area protected from sunlight.
- Some species are sensitive to light and must be covered.
- Doors should not be subjected to extremes of heat and/or humidity conditions. Relative humidity should not be less than 30% or more than 60%.
- Store doors in closed-in buildings with operational HVAC systems.
- Cover doors to keep clean, but allow air circulation.
- Seal at earliest possible moment. Edge sealing is particularly important.
- Lift or carry doors. Do not drag one door against another.
- Handle doors with clean hands or clean gloves. Do not walk on or place other materials on top of stacked doors.

Field Finishing

- Just prior to staining, sealing, and finishing, doors must be completely block sanded in a horizontal position by the finisher with not less than 150 grit sandpaper, to remove all handling marks and raised grain.
- If possible, test surface for compatibility with finish.
- Top, bottom, opening, and hardware recess edges must be sealed after fitting with at least two (2) coats of oil-based paint, varnish or lacquer.

- Water-based stains, paints or latex primers should be avoided whenever possible because they raise the grain, may cause veneer splits, and have a tendency to highlight veneer joints.
- Avoid dark colors on exterior doors in direct sunlight.
- Do not use steel wool on oak-veneered or fire-rated doors.
- A wash coat (thin sealer) should be applied prior to the use of a dark stain to avoid a splotchy appearance and/or sharp contrast in color.
- High humidity conditions will adversely affect the finish appearance.
- Manufacturers' warranties do not cover the appearance of field-applied finishes.

Installation

- Allow doors to become acclimated to finished building heat and humidity before fitting and hanging.
- Utility or strength of doors must not be impaired by fitting to the opening, applying hardware, plant-ons, louvers, or other detailing.
- In fitting for width, trim equally from both sides, allowing 1/8" clearance at top and each side.
- In fitting for height, do not trim top edges on labeled doors, and on non-rated doors do not trim top and bottom edge more than 3/4" unless accommodated by additional blocking.
- Threaded-to-the-head wood screws are preferable for fastening all hardware on non-rated doors and required on all rated doors. Pilot holes must be drilled for all screws to avoid splitting.

- Use two (2) hinges for doors up to 60" in height, three (3) hinges for doors up to 90" in height, and an additional hinge for every additional 30" of door height or portion thereof.

See also Fire Door Requirements.

Fire Door Requirements

- GENERAL—Install doors as required by NFPA Pamphlet 80. All 20, 45, 60 and 90 minute rated doors may be hung with either half surface or full mortise hinges. Core reinforcements can be specified to permit hardware to be surface mounted with screws. Labels shall not be removed from fire-rated doors.
- 20, 45, 60 and 90 minute rated doors—Preparation of fire door assemblies must be done under label service in accordance with the manufacturer's service procedure. This includes trimming for size, except a maximum 3/4" off the bottom of the door, and preparation for locks, latches, hinges, closers, lights, louvers, astragals and any fabrication.
- It is absolutely necessary to predrill pilot screw holes when mounting hardware. When installing butt hinges use #12 x 1-1/4" threaded-to-the-head steel screws with constant diameter wood threads. Drill 5/32" diameter pilot holes for #12 screws. Failure to drill correct size pilot holes could result in stile splitting and void the warranty of the door.

Field Painting of Timely Prefinished Frames



If field painting is required over the standard Timely factory prefinished frame, please observe the following.

1. A micro-layer of wax is applied to the frame as a lubricant during manufacturing. It must be removed prior to applying paint to ensure proper adhesion.
2. Wipe the frame, using protective gloves, with a good cleaner whose use is allowed by local authorities (ex.: paint thinner, isopropyl alcohol, Simple Green, etc.)
3. Wipe the frame so it is completely dry and dust free. The best adhesion is achieved by carefully preparing the base. We strongly recommend rubbing all surfaces with a Scotch Brite (fine to medium pad) after cleaning. Wipe the frame so it is completely dry and dust free. Painting should be done immediately after cleaning to prevent a dust build-up. This is especially important when water based paints will be used.
4. AS A RESULT OF STRINGENT ENVIRONMENTAL RESTRICTIONS, WATER BASED PAINTS ARE FAST BECOMING THE ACCEPTED STANDARD. DUE TO THE LARGE VARIETY OF THESE PAINTS, IT BECOMES IMPERATIVE THAT A SAMPLE TEST IS MADE PRIOR TO PAINTING TO ASSURE PAINT COMPATIBILITY AND ADHESION.
5. Although acrylic water based paints are dry to the touch in an hour or so, they usually require between 10 to 14 days before they are fully cured. This can be tested by pressing the edge of your fingernail against the paint. If an impression is left then the paint is not yet fully cured.
6. To insure good adhesion of acrylic water based paints, a prime coat is necessary prior to top coat.
7. If you plan to paint over light and dark finishes with the same color, then a prime coat will be required to achieve uniform color.
8. If priming is necessary, follow steps 1 through 3.

Anemostat

Beveled VISION Light with continuous glass retainer recommended for applications where total visibility and light transmissions are required.



FIRE RATED METAL VISION INSERTS – Bronze Baked Enamel								
Beveled Vision Insert Order Size	Exposed Glass Size	Frame Kit ONLY no glass (not installed)	Frame Kit with Wire glass (not installed)	Frame Kit with SAFE-Wire glass (not installed)	Frame with Glass - Installed			
					Hollow Metal Door		Wood Door	
Diamond Pattern Wire 1/4" Glass								
5" x 35"	3" x 33"	\$70.00	\$106.00	\$139.00	\$192.00	\$225.00	\$137.00	\$170.00
6" x 27"	4" x 25"	70.00	106.00	139.00	192.00	225.00	137.00	170.00
7" x 22"	5" x 20"	70.00	106.00	139.00	192.00	225.00	137.00	170.00
12" x 12"	10" x 10"	43.00	73.00	134.00	159.00	220.00	104.00	165.00
24" x 30"	22" x 28"	89.00	222.00	367.00	308.00	453.00	253.00	398.00
24" x 32"	22" x 30"	89.00	231.00	367.00	317.00	453.00	262.00	398.00

Maximum 100 square inches for 60 and 90 minute fire rated doors.
Maximum 1,296 square inches for 20 and 45 minute fire rated doors.

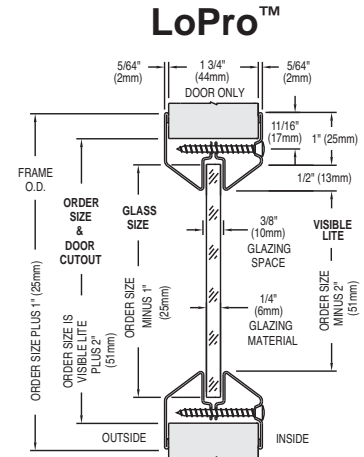

NON-RATED METAL VISION INSERTS – Primed Grey					
Beveled Vision Insert Order Size	Exposed Glass Size	Frame Kit ONLY no glass (not installed)	Frame Kit with Wire glass (not installed)	Frame with Glass - Installed	
				Hollow Metal Door	Wood Door
1/4" Clear Tempered Glass					
5" x 35"	3" x 33"	\$ 70.00	\$ 95.00	\$181.00	\$126.00
6" x 27"	4" x 25"	70.00	95.00	181.00	126.00
7" x 22"	5" x 20"	70.00	95.00	181.00	126.00
12" x 12"	10" x 10"	43.00	68.00	154.00	99.00
24" x 30"	22" x 28"	89.00	150.00	236.00	181.00
24" x 32"	22" x 30"	89.00	150.00	236.00	181.00
24" x 60"	22" x 58"	169.00	283.00	392.00	326.00
3/4" Tempered Insulating Glass					
24" x 30"	22" x 28"	\$129.00	\$252.00	\$338.00	\$283.00
24" x 60"	22" x 58"	267.00	513.00	622.00	544.00
3/4" Tempered Insulating Glass w/9-Light Internal Muntin Bars *					
23" x 37"	21" x 35"	\$189.00	\$362.00	\$448.00	\$393.00

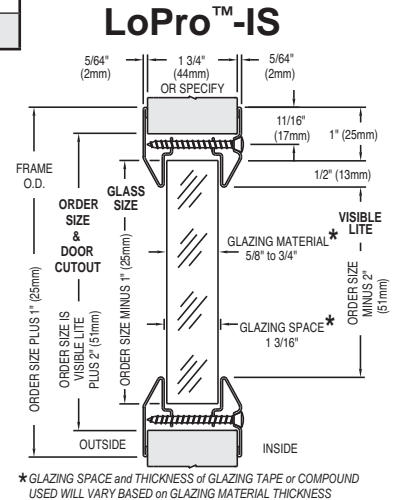

* GLAZING SPACE and THICKNESS of GLAZING TAPE or COMPOUND USED WILL VARY BASED on GLAZING MATERIAL THICKNESS

* Not available for use with Amweld 6100 6-Panel Doors.

CONSULT LOCAL CODES ON REQUIREMENTS FOR FIRE RATED OPENINGS

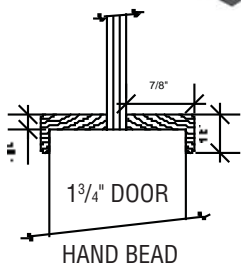

Vision Insert (exposed glass size)	NON-RATED VISION INSERTS (Installed) for Wood Doors							
	WOOD HAND BEAD							
	Unfinished Birch		Prefinished Birch †		Unfinished Oak		Prefinished Oak †	
	Bead Only (no Glass)	1/4" Clear Tempered Glass	Bead Only (no Glass)	1/4" Clear Tempered Glass	Bead Only (no Glass)	1/4" Clear Tempered Glass	Bead Only (no Glass)	1/4" Clear Tempered Glass
3" x 33"	\$79.00	\$104.00	\$ 98.00	\$123.00	\$79.00	\$104.00	\$98.00	\$123.00
4" x 25"	79.00	104.00	98.00	123.00	79.00	104.00	98.00	123.00
5" x 20"	79.00	104.00	98.00	123.00	79.00	104.00	98.00	123.00
10" x 10"	79.00	104.00	98.00	123.00	79.00	104.00	98.00	123.00
22" x 28"	79.00	140.00	98.00	159.00	79.00	140.00	98.00	159.00
22" x 30"	79.00	140.00	98.00	159.00	79.00	140.00	98.00	159.00
22" x 58"	92.00	206.00	114.00	228.00	92.00	206.00	114.00	228.00

• DOOR LIGHT CUT-OUT:

† Matches Mohawk clear prefinished door.

For fire rated/labeled doors - cut-outs must be a minimum of 6" from edge of door and/or other cut-outs.

For non-rated doors - a minimum of 5" must be maintained.

A spring-loaded fusible link mechanism is incorporated into the design. Upon melting of the link, the action bar is actuated thereby closing and locking all of the blades. Louver assembly is 1⁹/₁₆" deep.

MODEL: FLDL-UL

Model 1900-A door louver is listed by U.L. and WHI and is ideal for use in fire doors up to 90 minute rating. The Listing Mark is provided on the frame of the louver.

Finish: Bronze Baked Enamel



40% free air flow area.

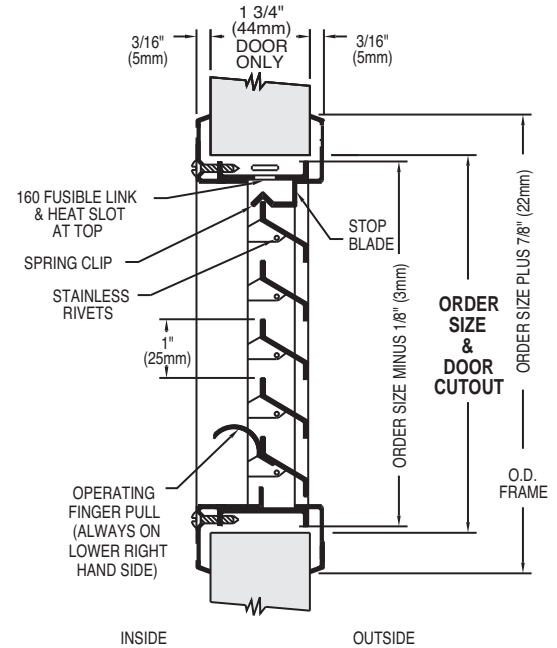

90-MINUTE FIRE RATED FUSIBLE LINK LOUVERS - METAL				
Model FLDL-UL Fusible Link Louver	Louver Only	Louver - Installed		Net Free Air in Square Inches
		Hollow Metal Door	Wood Door	
18" x 18"	\$216.00	\$302.00	\$236.00	129
24" x 12"	203.00	289.00	223.00	115
24" x 24"	241.00	327.00	276.00	230

Fusible link louvers are allowed in 45, 60, and 90-minute architectural doors.

CONSULT LOCAL CODES ON REQUIREMENTS FOR FIRE RATED OPENINGS

MODEL: AFDL

Features non-vision inverted "Y" blades. Fastening system leaves corridor side of door free of fasteners.

Finish: Bronze Baked Enamel



Vandal-proof design; basic blade unit with flanged frame welded to face (corridor) side and separate removable flanged frame on opposite side; fits 1³/₄" thick doors only. 50% free air flow area.

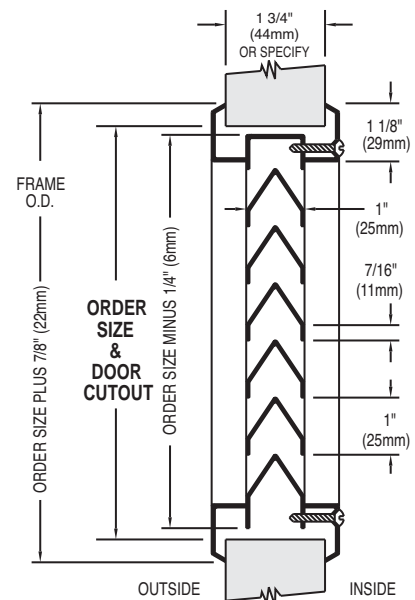

METAL DOOR LOUVERS				
Model AFDL Door Louver	Louver Only	Louver - Installed		Net Free Air in Square Inches
		Hollow Metal Door	Wood Door	
18" x 12"	\$ 73.00	\$159.00	\$ 95.00	108
24" x 12"	89.00	175.00	126.00	144
24" x 24"	127.00	213.00	173.00	288

Not allowed in fire rated doors.

DOOR LIGHT CUT-OUT: For fire rated/labeled doors - cut-outs must be a minimum of 6" from edge of door and/or other cut-outs. For non-rated doors - a minimum of 5" must be maintained.

HAGER COMMERCIAL HINGES

MORTISE HINGES - (prices are for each hinge)

	FULL MORTISE HINGES 4 1/2" x 4 1/2"	PRIMED USP	BRIGHT BRASS US3	DULL BRASS US4	BRONZE US10	BRONZE US10A	OIL-RUBBED BRONZE US10B	CHROME US26	BRUSHED CHROME US26D	STAINLESS STEEL US32D
STEEL BASE	Standard Weight Plain Bearing	EC1100 \$ 3.50 ea.	EC1100 \$ 6.00 ea.	EC1100 \$ 4.50 ea.	1279 \$ 5.00 ea.	-	EC1100 \$6.00 ea.	EC1100 \$6.00 ea.	EC1100 \$5.00 ea.	-
	Standard Weight Plain Bearing Non-Removable Pin	EC1100 NRP 5.00 ea.	-	-	-	-	-	-	EC1100 NRP 6.00 ea.	-
	Standard Weight Ball Bearing	ECBB1100 6.00 ea.	ECBB1100 11.00 ea.	ECBB1100 9.00 ea.	BB1279 10.00 ea.	-	ECBB1100 11.00 ea.	ECBB1100 11.00 ea.	ECBB1100 8.20 ea.	BB1191 \$30.00 ea.
	Standard Weight Ball Bearing Non-Removable Pin	ECBB1100 NRP 8.50 ea.	ECBB1100 NRP 13.00 ea.	ECBB1100 NRP 10.00 ea.	BB1279 NRP 12.00 ea.	-	-	-	ECBB1100 NRP 9.50 ea.	BB1191 NRP 32.00 ea.
	Standard Weight Spring Hinge	EC1105 20.00 ea.	EC1105 30.00 ea.	EC1105 30.00 ea.	1250 33.00 ea.	1250 \$33.00 ea.	EC1105 30.00 ea.	-	EC1105 30.00 ea.	-
	Heavy Weight Ball Bearing	BB1168 23.00 ea.	BB1168 29.00 ea.	BB1168 29.00 ea.	BB1168 29.00 ea.	-	-	-	BB1168 29.00 ea.	-
BRASS BASE	Standard Weight Plain Bearing	BB1191 22.00 ea.	BB1191 29.00 ea.	BB1191 22.00 ea.	BB1191 22.00 ea.	-	-	-	BB1191 26.00 ea.	-

ROTON HINGES - Continuous Geared Hinge – Heavy Duty

- PK 780-112HD 83" Concealed Leaf **\$175.00**
- PK 780-157HD 83" Full Surface Mount **268.00**

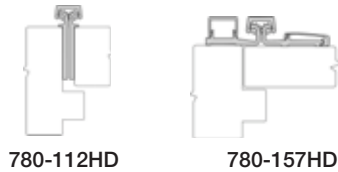

HAGER DOOR CLOSERS

With Hager, you get a door closer that's packaged with everything needed for quick installation, regardless of the application. Hager door closers are tri-packed for mounting three ways: parallel arm, regular arm, and top jamb. They are non-handed, packaged with a parallel arm bracket and thru-bolts at no extra charge, and adjustable for various door sizes.

Hager Door Closers –

- Extra Heavy Duty, Commercial
- Grade 1
- Tri-Pack Mount – Regular, Top-Jamb, Parallel Arm
- Wood Screws, Machine Screws, Thru-Bolts
- Size: Adjustable 1-4 Adjustable Latch & Sweep Speeds, Backset
- Painted Finishes

Hold open feature not to be used in fire rated openings.



5100
Cast Iron Body



5200
Aluminum Body



5300
Aluminum Body



380S
Magnetic Door Holder

	ALM	DBZ	Gold
5100	\$265.00	\$265.00	-
5100HO	295.00	295.00	-
5200 Slim Line	205.00	215.00	-
5200HO Slim Line	245.00	245.00	-
5300	179.00	179.00	\$179.00
5300HO	209.00	209.00	209.00
Long Arms for 5200 & 5300 5908	35.00	35.00	35.00
380S Magnetic Door Holder - Luma Sheen (24V x 120V)	230.00	-	-

NOTES: Items priced in *italics* are Factory Order – Please allow additional lead time.
 Must be selected for a Fire Rated Opening.

LCN

**10-Year
Warranty**

Features:

- Non-Handed and Tri-Mount
 - UL Listed
 - 180° Maximum Opening
 - Powder Coat Finish
 - ADA Compliant
 - Adjustable Backcheck
 - Includes 62PA Bracket and Thru-Bolts
 - (H) Hold-open Arm*
- * Hold-open feature not to be used in Fire Rated openings.



1261
Adjustable size 1-5

Aluminum Finish		Dark Bronze Finish	
P1371	P1371H*	P1371	P1371H*
\$194.00	\$209.00	\$194.00	\$209.00
1370-79 Long Arm Adapter			
ADD		ADD	
\$57.00		\$57.00	
Interior or Exterior Use			



4030
Adjustable size 1-4

Aluminum Finish		Dark Bronze Finish	
4030	4030H*	4030	4030H*
\$353.00	\$382.00	\$353.00	\$382.00



7830 Wall Magnet

Model 7830
\$249.00

Features:

- Aluminum Finish
- UL Listed
- Wall units should be wall mounted per template instructions
- Suitable for use in pocket installations
- Total projection is 4 1/16"
- Dual Voltage (field selectable 120V or 24V)

Special Orders are available - please inquire.



DOR-O-MATIC

**10-Year
Warranty**

Features:

- Non-Handed and Tri-Mount
- UL Listed
- 180° Maximum Opening
- ADA Compliant
- Adjustable Backcheck
- Includes PA Bracket and Thru-Bolts
- Cast Aluminum with Plastic Cover
- Interior or Exterior Use



SC60 (9 1/16" Unit)
Adjustable size 2-5

Aluminum Finish	Brass Finish
\$164.00	\$164.00

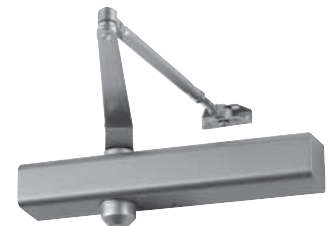

SC80 (12" Unit)
Adjustable size 2-5

Aluminum Finish	Brass Finish
\$230.00	\$230.00

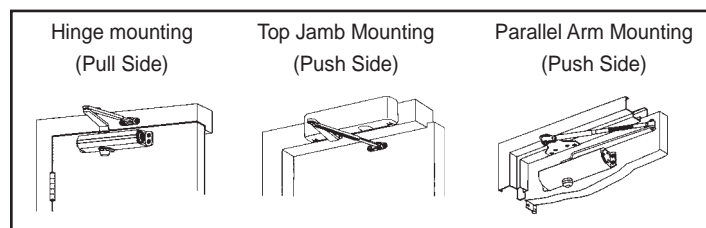

- S-Series / A-Series – no Thru-Bolts Required for doors with 4⁹/₁₆" stiles.
- AL-Series / D-Series – Thru-Bolt Mounting for doors with wide stiles.
- Supplied 2³/₄" Backset
- ASA Strike Included
- Everest C123 Keyway

Contact BROSCO offices for additional keying services.

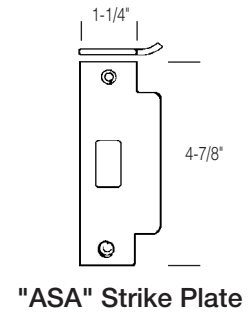
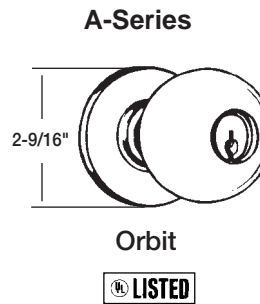
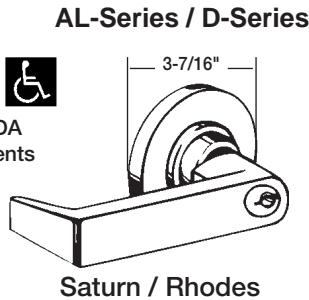
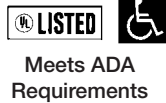
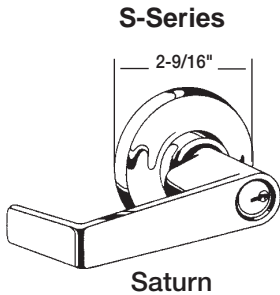

Function	GRADE 2 Medium Duty		GRADE 2 Standard Duty			GRADE 1 Heavy Duty
	Brushed Chrome	Brushed Chrome	Bright Brass	Brushed Chrome	Bright Brass	Brushed Chrome
	A-Series Orbit (626)	S-Series Saturn (626)	S-Series Saturn (605)	AL-Series Saturn (626)	AL-Series Saturn (605)	D-Series Rhodes (626)
Passage	\$ 80.00	\$127.00	\$138.00	\$143.00	\$153.00	\$266.00
Privacy	86.00	158.00	167.00	161.00	171.00	307.00
Entrance	153.00	199.00	209.00	208.00	218.00	365.00
Classroom	–	199.00	209.00	208.00	218.00	365.00
Storeroom	153.00	199.00	209.00	208.00	218.00	365.00
Single Dummy	–	61.00	66.00	81.00	86.00	–
Single Cylinder Deadbolt (BC-560P)	49.00	49.00	54.00	49.00	54.00	–

Passage (F75)

Function #: A10S, S10D, AL10S, D10S
Both knobs/levers always unlocked.

Outside | Inside

Classroom (F84)

Function #: S70PD, AL70PD, D70PD
Outside knob/lever locked and unlocked by key. Inside knob/lever always unlocked.

Outside | Inside

Privacy – Bedroom – Bathroom (F76)

Function #: A40S, S40D, AL40S, D40S
Push button locking. Can be opened from outside with a small tool. Turning inside knob/lever releases push-button. Closing door on all except F40 and S40D also releases button.

Outside | Inside

Storeroom (F86)

Function #: A80PD / S80PD, AL80PD / BD D80PD / BD
Outside knob/lever fixed. Entrance by key only. Inside knob/lever always unlocked.

Outside | Inside

Entrance (F82)

Function #: A53PD / S51PD, AL53PD / BD D53PD / BD
Turn/push-button locking. Pushing and turning button locks outside knob/lever requiring use of key until button is manually unlocked. Push-button locking: Pushing button locks outside knob/lever until unlocked by key or by turning inside knob/lever.

Outside | Inside

Single Dummy

Function #: S170, AL170
Single Dummy trim for one side of door. Used for door pull or as matching inactive trim.

Outside | Inside

Single Cylinder Deadbolt (E2152)

Function #: BC-160N
Deadbolt thrown or retracted by key from outside or by inside turn unit. Bolt automatically deadlocks when fully thrown.

Outside | Inside

Hager locks are manufactured to the highest quality standards and extensively tested to ANSI standards and BHMA certification requirements. In addition, all locks comply with ADA requirements outlined in ANSI A117.1 and are UL Listed up to 3 hours for "A" label doors.

3400 Series –

- Extra Heavy Duty, Commercial, Industrial, Institutional
- Grade 1
- Thru-Bolt Mounting
- 3⁹/₁₆" Rose Diameter
- Cylindrical Lock, 6 Pin "C" Keyway
- ANSI Strike



3400 Series	US26D
3410 Passage	<i>\$150.00</i>
3440 Privacy	<i>175.00</i>
3453 Entrance	<i>200.00</i>
3470 Classroom	<i>200.00</i>
3480 Storeroom	<i>200.00</i>

3500 Series –

- Standard Duty, Commercial
- Grade 2
- Thru-Bolt Mounting (Lever only)
- 3³/₈" Rose Diameter (Knob)
- Cylindrical Lock, 6 Pin "C" Keyway
- ANSI Strike



Apollo



Withnell

3500 Series	US32D	US3	US26D
	Apollo	Withnell	Withnell
3510 Passage	\$ 45.00	<i>\$115.00</i>	\$115.00
3517 Dummy	-	<i>70.00</i>	70.00
3540 Privacy	50.00	<i>125.00</i>	125.00
3553 Entrance	65.00	<i>150.00</i>	150.00
3570 Classroom	-	<i>150.00</i>	150.00
3580 Storeroom	65.00	<i>150.00</i>	150.00

3600 Series –

- Heavy Duty, Residential
- Grade 2
- Thru-Bolt Mounting (Lever only)
- 3" Rose Diameter
- Tubular Lock, 6 Pin "C" Keyway
- ANSI Strike
- 2¹/₄" x 1" Latch Face



3600 Series	US3	US26D
	Withnell	Withnell
3610 Passage	\$80.00	\$80.00
3617 Dummy	45.00	45.00
3640 Privacy	80.00	80.00
3653 Entrance	90.00	90.00
3670 Classroom	90.00	90.00
3680 Storeroom	90.00	90.00

3200 Series –

- Auxiliary & Primary Locking
- Grade 2
- Cylindrical Lock, 6 Pin "C" Keyway
- 1¹/₈" x 2³/₄" Square Corner Strike



3200 Series	US3	US26D
3215 Single Cylinder Deadbolt	<i>\$50.00</i>	\$50.00

Accessories –



ASA Strike

US3	US26D
\$12.00	\$12.00

Replacement Key (blank)
\$3.00

NOTES: Items priced in *italics* are Factory Order – Please allow additional lead time.

All Hager exit devices meet UL specifications for panic devices and are fire rated for up to three hours. Hager exit devices are packaged for convenience and versatility, with thru-bolts included for every model, slotted strikes, non-handed designs, plus escutcheon trim available in four functions (dummy, blank, entry and night latch).

4500 Exit Devices –

- Heavy Duty, Commercial
- Hex Dogging for Non-Fire Rated
- Wood Screws, Machine Screws, Thru-Bolts



4500 Rim Device

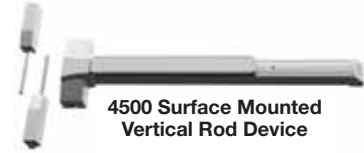

4500 Surface Mounted Vertical Rod Device



4500 Series

	US3	US10B	US26D
4500 Rim Exit Device 3'-0"	\$ 650.00	\$ 650.00	\$ 489.00
4500 Rim Exit Device 4'-0"	638.00	638.00	623.00
🔥 4500F Rim Exit Device 3'-0" FIRE RATED	800.00	800.00	600.00
🔥 4500F Rim Exit Device 4'-0" FIRE RATED	990.00	990.00	790.00
4500 Surface Vertical Rod Exit Device 3'-0" x 6'-8"/7'-0"	1040.00	1040.00	750.00
4500 Surface Vertical Rod Exit Device 4'-0" x 6'-8"/7'-0"	1240.00	1240.00	950.00
4500 Surface Vertical Rod Exit Device 3'-0" x 8'-0"	1310.00	1310.00	1020.00
4500 Surface Vertical Rod Exit Device 4'-0" x 8'-0"	1510.00	1510.00	1220.00
🔥 4500F Surface Vertical Rod Exit Device 3'-0" x 6'-8"/7'-0" FIRE RATED	1115.00	1115.00	825.00
🔥 4500F Surface Vertical Rod Exit Device 4'-0" x 6'-8"/7'-0" FIRE RATED	1315.00	1315.00	1095.00
🔥 4500F Surface Vertical Rod Exit Device 3'-0" x 8'-0" FIRE RATED	1190.00	1190.00	1050.00
🔥 4500F Surface Vertical Rod Exit Device 4'-0" x 8'-0" FIRE RATED	1390.00	1390.00	1250.00
45BE Blank Escutcheon Trim w/Withnell Lever	350.00	350.00	200.00
45CE Cylinder Escutcheon Trim w/Withnell Lever & Cylinder	383.00	383.00	233.00
45DT Dummy Escutcheon Trim w/Whitnell Lever	350.00	350.00	200.00
45NL Night Latch Escutcheon Trim w/Whitnell Lever & Cylinder	383.00	383.00	233.00
45PD Pull Plate Dummy Trim	175.00	175.00	100.00
45PN Pull Plate w/Night Latch & Cylinder	223.00	223.00	153.00

4700 Exit Devices –

- Standard Duty, Commercial
- Hex Dogging for Non-Fire Rated
- Wood Screws, Machine Screws, Thru-Bolts
- Handed Trim



4701 Rim Device

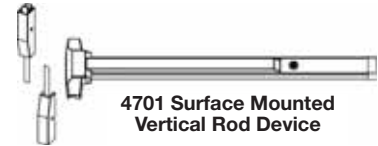

4701 Surface Mounted Vertical Rod Device

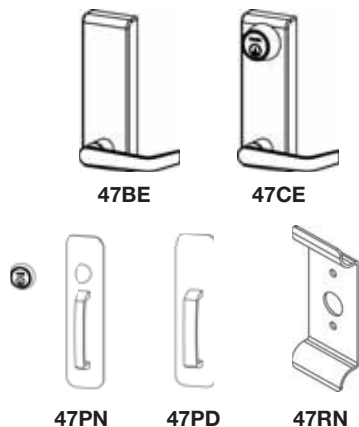

4700 Series

	ALM	DBZ
4701 Rim Exit Device 3'-0"	\$186.00	\$186.00
4701 Rim Exit Device 4'-0"	230.00	230.00
🔥 4701F Rim Exit Device 3'-0" FIRE RATED	240.00	240.00
4701 Surface Vertical Rod Exit Device 3'-0" x 6'-8"/7'-0"	320.00	320.00
4919 Rod Kit for 8'-0"	26.00	26.00
🔥 4701F Surface Vertical Rod Exit Device 3'-0" x 6'-8"/7'-0" FIRE RATED	429.00	429.00
🔥 4701F Surface Vertical Rod Exit Device 3'-0" x 8'-0" FIRE RATED	535.00	535.00
47BE Blank Escutcheon Trim w/Withnell Lever ☼	183.00	183.00
47CE Cylinder Escutcheon Trim w/Withnell Lever & Cylinder ☼	216.00	216.00
47DT Dummy Escutcheon Trim w/Whitnell Lever ☼	179.00	179.00
47NL Night Latch Escutcheon Trim w/Whitnell Lever & Cylinder ☼	216.00	216.00
47PD Pull Plate Dummy Trim	85.00	85.00
47PN Pull Plate w/Night Latch & Cylinder	108.00	108.00
47RD Raised Lip Pull Dummy Trim	50.00	50.00
47RN Raised Lip Pull w/Night Latch & Cylinder	85.00	85.00
4931R Rim Shim Kit ALM (1/8" thick)	50.00	50.00
4931S Surface Vertical Rod Shim Kit ALM (1/8" thick)	55.00	55.00
2-649-0137 Retain Cup (181 Prep)	9.00	-
4910 Rim Strike US32D	45.00	-

☼ 47 Lever Trim is Handed - specify LHR or RHR

Lock Cylinders for 4500 or 4700

	US26D	US10B
3901 Rim Cylinder US26D	\$33.00	\$33.00
3902 Mortise Cylinder 1-1/8" US26D	33.00	33.00



NOTES: Items priced in *italics* are Factory Order – Please allow additional lead time.

🔥 Must be selected for a Fire Rated Opening.

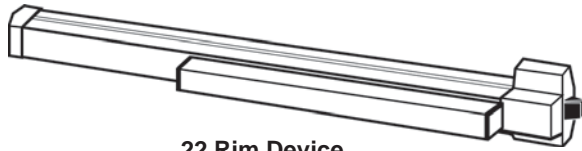

22 Rim Device

- Non-handed
- Latch bolt deadlocking
- 3/4" throw latch bolt
- Minimum Stile width – 4 3/4"
- Field sizeable
 - 3'-0" (fits doors 2'-6" to 3'-0" x 1 3/4")

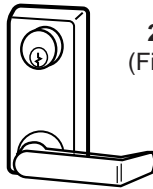

230L Lever
(Field Handed)

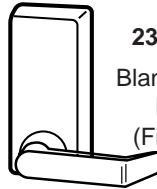

230L-BE Lever
Blank Escutcheon
Lever Trim
(Field Handed)

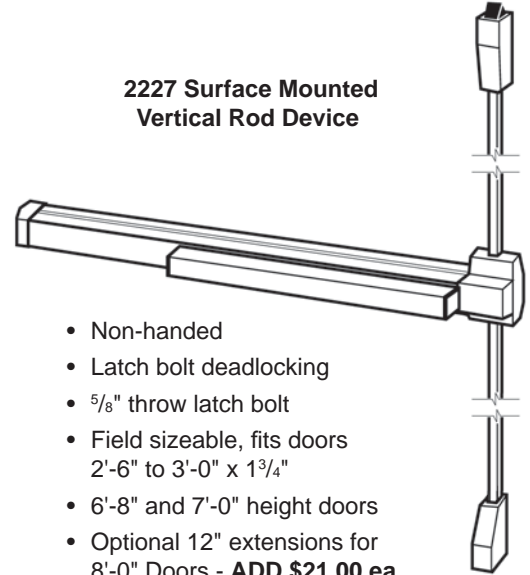

**2227 Surface Mounted
Vertical Rod Device**

- Non-handed
- Latch bolt deadlocking
- 5/8" throw latch bolt
- Field sizeable, fits doors 2'-6" to 3'-0" x 1 3/4"
- 6'-8" and 7'-0" height doors
- Optional 12" extensions for 8'-0" Doors - **ADD \$21.00 ea.** (Non-Fire Rated)

OPERATION OUTSIDE BY LEVER EXCEPT WHEN LOCKED BY KEY

Includes:

			Sprayed Aluminum SP28	Sprayed Bronze SP313
FIRE RATED	🔥 22 L-F	Fire Exit Rim Device, Strike, 230L Keyed Lever & Thru Bolts	\$ 832.00	\$ 832.00
	🔥 22 L-BE-F	Fire Exit Rim Device, Strike, 230L Lever Trim & Thru Bolts	780.00	780.00
	🔥 2227 L-F	Fire Exit Surface Vertical Rod Device, Strike, 230L Keyed Lever & Thru Bolts	1253.00	1253.00
	🔥 2227 L-BE-F	Fire Exit Surface Vertical Rod Device, Strike, 230L-BE Lever Trim & Thru Bolts	1201.00	1201.00
NON-RATED	22 L	Rim Device, Strike, 230L Keyed Lever & Thru Bolts	728.00	728.00
	22 L-BE	Rim Device, Strike, 230L-BE Lever Trim & Thru Bolts	676.00	676.00
	2227 L	Surface Vertical Rod Device, Strike, 230L Keyed Lever & Thru Bolts	1028.00	1028.00
	2227 L-BE	Surface Vertical Rod Device, Strike, 230L-BE Lever Trim & Thru Bolts	976.00	976.00

NO OUTSIDE OPERATION – "FOR EXIT ONLY"

Includes:

			Sprayed Aluminum SP28	Sprayed Bronze SP313
FIRE RATED	🔥 22 EOF	Fire Exit Rim Device, Strike & Thru Bolts	\$ 570.00	\$ 570.00
	🔥 2227 EOF	Fire Exit Surface Vertical Rod Device, Strike & Thru Bolts	1008.00	1008.00
NON-RATED	22 EO	Rim Device, Strike & Thru Bolts	466.00	466.00
	2227 EO	Surface Vertical Rod Device, Strike & Thru Bolts	783.00	783.00

GLASS BEAD KITS (GBK) - to shim* Exit Device to fit over high-profile door lights and raised mouldings:

- Kit for Rim Exit Device only **ADD \$54.00** (each individual door)
- Kit for Exit Device with Vertical Rods **ADD 76.00** (each individual door)

NON-FIRE RATED EXIT DEVICES FOR DOUBLE DOOR UNITS

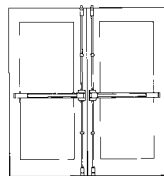

TYPE "A"
(2 Doors Active)

TYPE "A" PACKAGE INCLUDES:

- One 2227 EO Exit Device
- One 2227 L Exit Device w/Keyed Cylinder
- Thru Bolts
- Field Applied

	<u>LIST</u>
Sprayed Aluminum	\$1811.00
Sprayed Dark Bronze	1811.00

NOTES: 🔥 Must be Selected for a Fire Rated Opening.

* Shim kits are 1/4" thick.

THRESHOLDS – Mill Finish

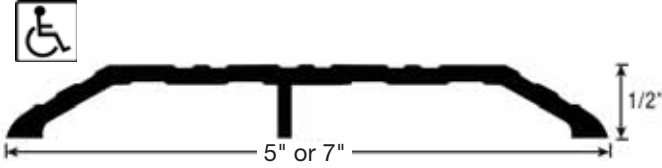

Saddle Threshold

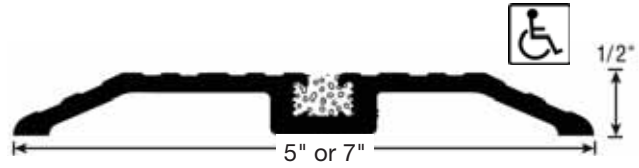

Thermal Barrier Threshold



Bumper Threshold

Thresholds - Mill Finish	3'-0"	4'-0"	6'-0"	8'-0"
412S 5" Saddle Threshold	\$30.00	\$45.00	\$ 65.00	\$ 90.00
416S 7" Saddle Threshold	60.00	75.00	115.00	155.00
412S 5" Thermal Barrier Threshold	45.00	60.00	105.00	-
423S 7" Thermal Barrier Threshold	65.00	90.00	140.00	-
477S Bumper Threshold	35.00	45.00	70.00	90.00

OPTIONAL ACCESSORIES (each)



Finish	190S Kick Plate 8" x 30"	190S Kick Plate 8" x 34"	30S Push Plate 4" x 16"	32G Pull Plate 4" x 16"	282D Flush Bolt	283D Flush Bolt	275D 8" Surface Bolt
US3	\$75.00	\$80.00	\$25.00	\$55.00	\$24.00	\$35.00	-
US26D	-	-	-	-	24.00	35.00	\$40.00
US32	45.00	50.00	13.00	42.00	-	-	-



Finish	232W Wall Stop Convex	236W Wall Stop Concave	242F Floor Stop Universal	267S Floor Stop	268S Floor Stop w/Hold Open	270C Door Holder w/Kick Down
US3	\$4.00	\$4.00	\$6.50	-	-	-
US26D	-	-	5.50	-	-	-
US32	3.00	3.00	-	-	-	-
Sprayed Brass	-	-	-	\$23.00	\$41.00	\$10.00
Sprayed DK Bronze	-	-	-	23.00	41.00	10.00
Sprayed Aluminum	-	-	-	18.00	25.00	10.00

NOTES: Items priced in *italics* are Factory Order – Please allow additional lead time.

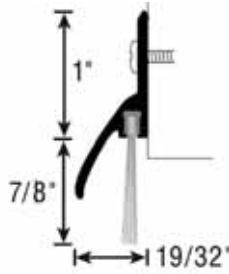

**770SB Door Sweep
w/Drip Cap
Mill/Brush**

3'-0"	\$19.00
4'-0"	28.00

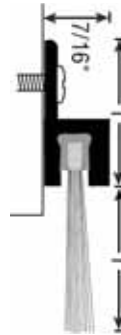

**801S Door Sweep
Mill/Brush**

3'-0"	\$19.00
4'-0"	28.00

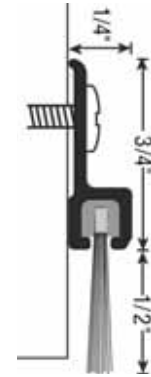

Note: 2 required for use as Astragal

802S Astragal and/or Frame Seal

	Mill	Dk Bnz
7'-0"	\$30.00	\$35.00
8'-0"	35.00	-

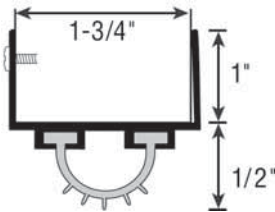

**779S Door Shoe
Mill/Vinyl**

3'-0"	\$15.00
4'-0"	20.00

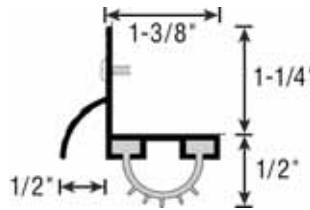

**777S Door Shoe
Mill/Vinyl**

3'-0"	\$12.00
4'-0"	23.00

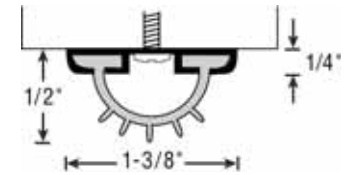

**774S Door Edge
Mill/Vinyl**

7'-0"	\$35.00
-------	----------------

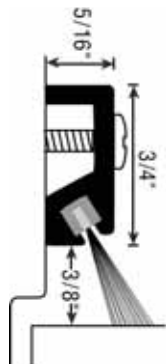

**800S Set Frame Seal
Mill/Brush**

3'-0" x 7'-0"	\$67.00
4'-0" x 7'-0"	71.00
6'-0" x 7'-0"	79.00
8'-0" x 7'-0"	86.00

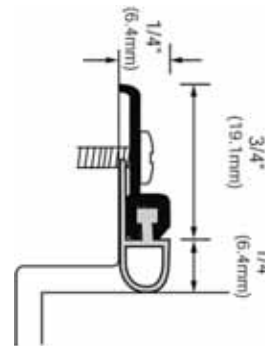

**801S Set Frame Seal
Mill/Bulb**

3'-0" x 7'-0"	\$55.00
4'-0" x 7'-0"	60.00
6'-0" x 7'-0"	65.00
8'-0" x 7'-0"	75.00



**736W Press-on
Perimeter Gasket 20"**

White	\$29.00
Charcoal	29.00

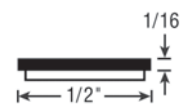

**729W Press-on
Intumescent Gasket 21"**

White	\$39.00
-------	----------------

New!

ACCESS DOORS

DW Series – Drywall Access Doors



- SDL - Screw Driver Latch, standard
- 16 Gauge Galvannealed Steel, Primed
- Concealed Hinge

Nominal Door Size	List Price
6 x 6	\$29.40
8 x 8	29.80
10 x 10	34.60
12 x 12	37.30
14 x 14	45.50
16 x 16	51.80
18 x 18	59.30
24 x 24	82.80

FR Series – Fire Rated Access Doors



- 90 Minute Rated for Walls - UL
- RTL - Recessed Thumb Latch standard
- 16 Gauge galvannealed Steel, Primed
- Concealed Hinge
- Door has Heavy Duty Spring to assure positive latching

Nominal Door Size	List Price
8 x 8	\$108.90
10 x 10	112.00
12 x 12	113.90
14 x 14	131.30
16 x 16	140.20
18 x 18	147.70
24 x 24	181.40

Call BROSCO for other series or size requirements.

Roof Access Hatch –

Roof Access Hatches are designed to provide convenient, cost saving access to the roofs of buildings, allowing for ladders and stair access to the roof from the interior below. Elmdor Roof Access Hatches are designed and engineered for durability and safety, with ease of installation. The Roof Access Hatches install easily over the roof opening and are secured from the base flange to the roof. Curb construction shall be 14 gauge (G90) galvanized steel with durable gray primer finish. It shall be 12" in height with a 3-1/2" wide mounting flange with mounting holes for roof attachment.

- **Cover** is 14 gauge (G90) galvanized steel with radius corners for safety and shall be fully welded at the corners for watertight construction.
- **Latching** shall include interior handle, exterior handle and provisions for a padlock, both inside and out.
- **Hardware** shall include an automatic, hold-open arm with vinyl grip and compression springs encased in telescopic tubes for smooth door operation.



Standard Sizes: (special sizes available upon request)

Size	Frame ID	Frame OD	Roof Opening	Shipping Weight
24 x 24	24 x 24	31 x 31	24 x 24	115 lbs.
24 x 30	24 x 30	31 x 37	24 x 30	125 lbs.
24 x 36	24 x 36	31 x 43	24 x 36	135 lbs.
30 x 36	30 x 36	37 x 43	30 x 36	155 lbs.
30 x 54	30 x 54	37 x 61	30 x 54	225 lbs.
30 x 96	30 x 96	37 x 103	30 x 96	335 lbs.
36 x 36	36 x 36	43 x 43	36 x 36	200 lbs.
48 x 48	48 x 48	55 x 55	48 x 48	430 lbs.

Call BROSCO for price and lead time

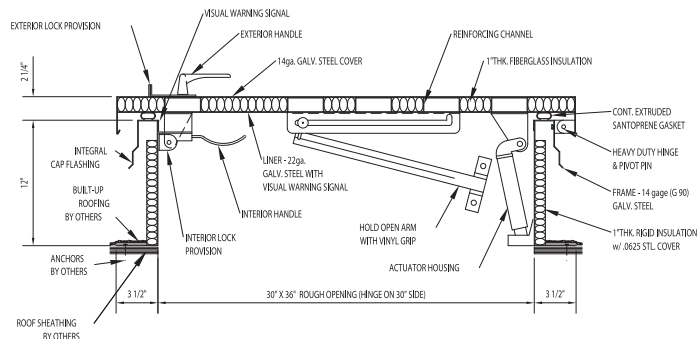

NOTES: Items priced in *italics* are Factory Order – Please allow additional lead time.

The 1½" handicap compliant railing offers commercial and residential low-maintenance solutions. Constructed of aluminum reinforced PVC, this rail is easy to install and offers added safety all while maintaining clean seams and joints.

Meets ADA standards I/A/W/ DOJ28 CFR Part 36 Section 4.

Can be used in conjunction with Smart Rail Composite Railing System or Premium PVC Railing System as well as existing railing systems.



Secondary ADA Railing Components

Handrail 1½" x 6'-0" with Insert (A)
Handrail 1½" Bracket with Screws (B)
32° 1½" Angle Bracket with Insert (C)
38° 1½" Angle Bracket with Insert (D)
90° 1½" Angle Bracket with Insert (E)
1½" Loop Return Angle Bracket with Insert (F)
1½" Wall Return Angle Bracket with Insert (G)
1½" End Cap (H)
6 Pack 1½" Expansion Joint Ring (I)

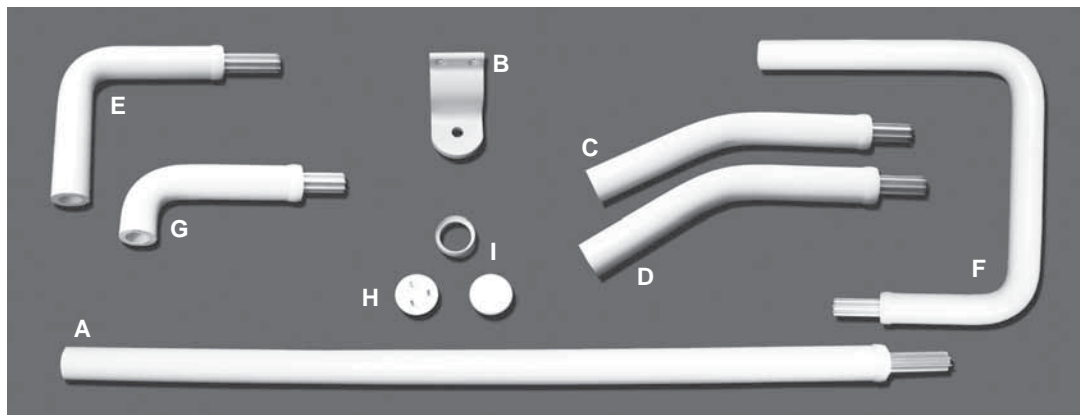

For Pricing, please see page RS-5 in the BROSCO "Millwork" Price Catalog.

Washroom Accessories and Partitions

by **Bradley** 

The BROSCO Commercial Group is proud to be the exclusive stocking distributor of Bradley Washroom Accessories and Mills Partitions.

Bradley Corporation is a leader in the Division 10 Products Industry. The Company boasts the greatest depth and breadth of commercial plumbing and washroom accessory products in the world.

BROSCO's extensive stock offering of these quality Bradley Products is available for immediate shipment to satisfy your customer needs. We also provide the entire Bradley product offering on a special order basis. Please call the BROSCO Commercial Group for further information.

You will find Bradley Products in Restaurants, Airports, Office Buildings, Stores, Hotels, Schools – all kinds of unexpected places.

BROSCO/Bradley is the one source for all your washroom accessory needs.

Mills Washroom Partitions
Bradley Washroom Accessories
Lenox Lockers
Health Care Units
Security Accessories

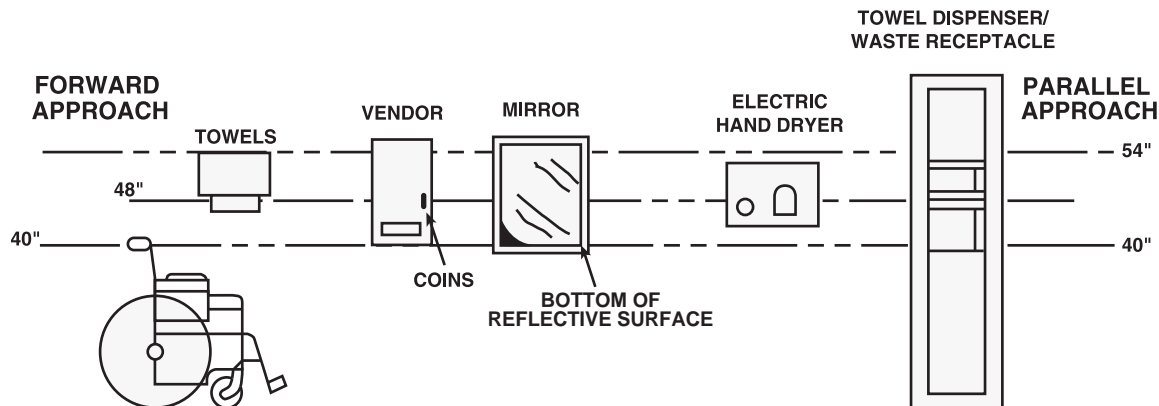
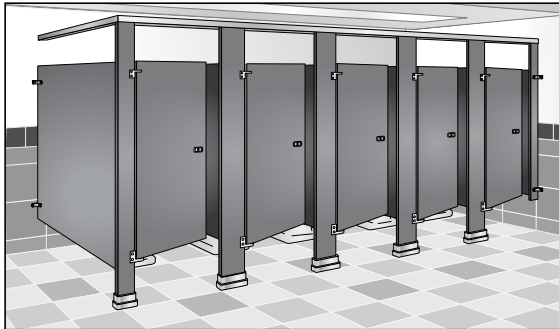

Diagram above shows ADA recommended mounting heights for washroom accessories.
 A minimum of 30" by 48" clear floor space is required in front of all accessible fixtures and accessories.

Sentinel™ Overhead Braced Series 400



Provides the most economical solution for heavy traffic and vandalism prone areas. Because it requires no special floor or ceiling construction, installation is easy in new or old buildings. The anti-grip rail provides outstanding rigidity.

Electro-Galvanized Steel
Baked Enamel Finish



*15-Year Warranty
against Rust-out*

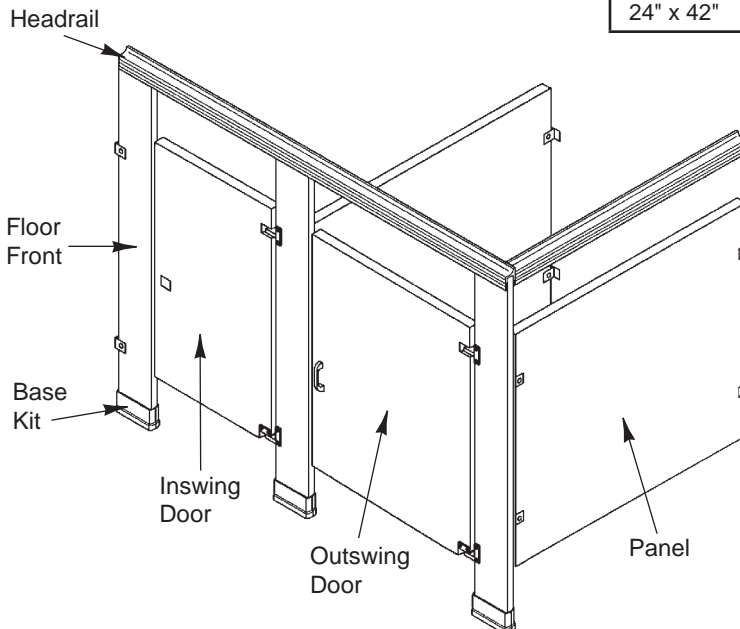

For Quoting Purposes Only

Panels with Hardware Kit				
Size	WARM GRAY	List Price	ALMOND	List Price
18" x 58"	T440-18-0412	\$161.50	T440-18-2103	\$161.50
24" x 58"	T440-24-0412	202.50	T440-24-2103	202.50
48" x 58"	T440-48-0412	301.90	T440-48-2103	301.90
54" x 58"	T440-54-0412	306.60	T440-54-2103	306.60
57" x 58"	T440-57-0412	316.10	T440-57-2103	316.10
60" x 58"	T440-60-0412	358.70	T440-60-2103	358.70
62" x 58"	T440-62-0412	363.40	T440-62-2103	363.40
72" x 58"	T440-72-0412	413.80	T440-72-2103	413.80

Floor Fronts with Hardware Kit and Base Kit				
5" x 69"	T569-05-0412	\$187.30	T569-05-2103	\$187.30
3" x 81"	T479-03-0412	104.50	T479-03-2103	104.50
4" x 81"	T479-04-0412	113.20	T479-04-2103	113.20
5" x 81"	T479-05-0412	126.60	T479-05-2103	126.60
6" x 81"	T479-06-0412	132.10	T479-06-2103	132.10
18" x 81"	T479-18-0412	252.90	T479-18-2103	252.90
24" x 81"	T479-24-0412	293.70	T479-24-2103	293.70

Floor Fronts with Hardware Kit and Base Kit				
7" x 81"	T479-07-0412	\$123.60	T479-07-2103	\$123.60
8" x 81"	T479-08-0412	135.20	T479-08-2103	135.20
10" x 81"	T479-10-0412	150.70	T479-10-2103	150.70
12" x 81"	T479-12-0412	163.20	T479-12-2103	163.20
14" x 81"	T479-14-0412	193.60	T479-14-2103	193.60

Telescoping Jamb Channel	T197-01-0412	\$210.80	T197-01-2103	\$210.80
Alcove Hardware Kit		HDWT-24AL	\$14.40	

Doors with Inswing or Outswing Hardware Kit				
24" x 58"	T490-24-0412	\$265.70	T490-24-2103	\$265.70
36" x 58"	T490-36-0412	327.20	T490-36-2103	327.20

UR Screen with Hardware Kit				
24" x 42"	T472-24-0412	\$243.20	T472-24-2103	\$243.20

Headrail with Hardware Kit		
120"	HDWT-A0158-120	\$117.30

All quotes or orders must include a layout to provide for proper hardware application.

Please send all Inquiries / Orders on
Washroom Partitions
to the **BROSCO Commercial Sales** office.
e-mail: commercialsales@broscocom

**Towel Dispensers
200 Series**

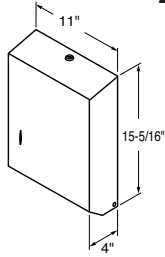

Model 250-15 \$75.00

Satin Finish - Surface Mount

Model 250-33 108.00

White - Surface Mount

**Toilet Tissue Holders
500 Series**



Model 505 \$20.00

Chrome Plated Die Cast Zinc



Model 5054 \$11.00

Chrome Plated Steel



Model 5071 \$14.00

Die Cast Aluminum
Controlled Delivery



Model 5084 \$23.00

Satin Finish

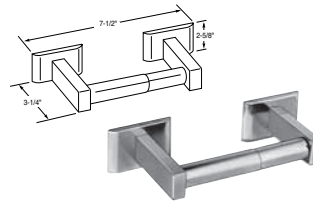

Model 508-32 \$18.00

Brushed Chrome



Model 5104 \$30.00

Satin Finish

**Waste Receptacle
300 Series**

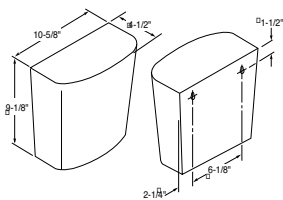

Model 357 \$132.00

Satin Finish

6.5 Gallon Stainless Steel Receptacle

**Vendor
400 Series**

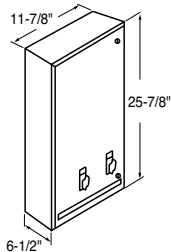

Model 426-45 \$663.00

Satin Finish - Surface Mount

.25¢ coinage

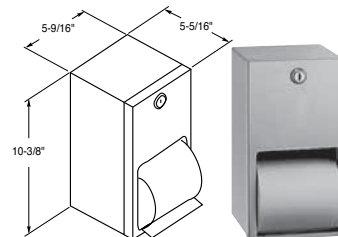

Model 5402 \$91.00

Satin Finish



Model 5224 \$20.00

Chrome Plated Steel

Disposal Unit

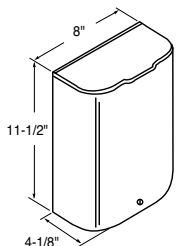

Model 4781-15 \$63.00

Satin Finish - Surface Mount



Model 5241-50 \$23.00

Die Cast Aluminum
Non-controlled Delivery



Model 5263 \$91.00

Satin Finish

Soap Dispensers
600 Series



Model 6481 \$14.00
Polished Chrome w/Plastic Bottle
16 oz. capacity

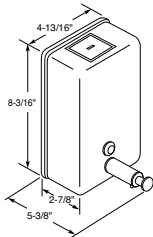

Model 6562 \$58.00
Satin Finish
40 oz. capacity

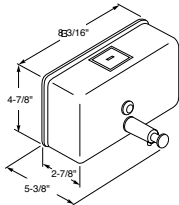

Model 6542 \$49.00
Satin Finish
40 oz. capacity



Mirrors and Shelves
700 Series



Model 780 \$119.00
18" x 24" \$119.00
18" x 30" 119.00
24" x 36" 141.00
Satin Finish - Angle Framed



Model 7805 \$179.00
Satin Finish - Angle Framed



Model 781 \$72.00
18" x 24" \$72.00
18" x 30" 85.00
Bright Annealed Finish
Channel Framed



Model 740 \$237.00
Satin Finish - Fixed Angle Tilt



Model 782 \$168.00
Satin Finish - Adjustable Tilt

Grab Bars and Rails
800 Series

8122 Series - 1 1/2" with Safety Grip Finish

- 8122-18 18" \$51.00**
- 8122-24 24" 56.00**
- 8122-30 30" 59.00**
- 8122-36 36" 63.00**
- 8122-42 42" 70.00**
- 8122-48 48" 74.00**



Model 8372-101 \$572.00
Safety Grip Finish

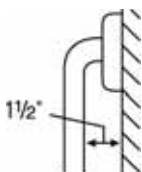

All grab bars are designed for the safety and security of the physically disabled. Standard safety clearances meets ADA requirements.

Bradex™

Concealed Mounting Kits
(includes 2 packs)
(needed for installation)

Stud Walls with Wood Supports

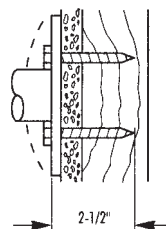

899-010 \$3.00

Panel Walls (Hollow)

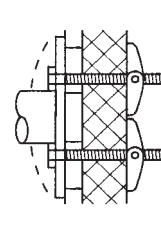

899-012 \$8.20

Masonry Walls

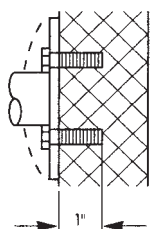

899-013 \$6.60

Let Us Help You Expand Your Business!

BROSCO Offers Commercial Services.

State-of-the-Art Shop
Warnock-Hersey Licensed
Full Line of Inventory
Dedicated Inside Sales Group
Complete Packages Available
Special Orders



BROSCO's Commercial Shop includes fully licensed Warnock-Hersey, Inc./Intertek Testing Services (WHI/ITS) labeling services for Wood Doors and Hollow Metal Products. BROSCO's "State-of-the-art" wood door machining equipment provides the capability to meet all of your architectural and commercial door requirements.

Industry Leading Brand Names

JELD-WEN
WINDOWS & DOORS

AMWELD

MOHAWK
FLUSH DOORS, INC.

TWELY
PREFINISHED STEEL DOOR FRAMES

ELMDOR
ACCESS DOORS
www.elmdor.com

HAGER
COMPANIES

LCN

Bradley

SCHLAGE

VON DUPRIN

Anemostat

DOR-O-MATIC