

# ☆☆ INSTALLATION INSTRUCTIONS ☆☆

## Exterior Door System – Wood • Fiberglass • Steel



Your reputation and ours depends on how well this Door is Installed

Most callbacks are due to improper installation. Before you proceed, please take time to review these installation tips. Thank you.

### 1. PREPARATION OF OPENING

#### OPENING SHOULD BE:

- PLUMB.** Use a 6' level (or shorter level with straight edge) to check plumb. Both sides of opening must be in same vertical plane. **SHIM OUT OF PLUMB WALL NOW.**
- LEVEL.** Check to see that sill and header are level.
- SQUARE.** Use a framing square to check that opening is square.
- CAULK.** Apply a double bead of caulking along sub-floor or slab.

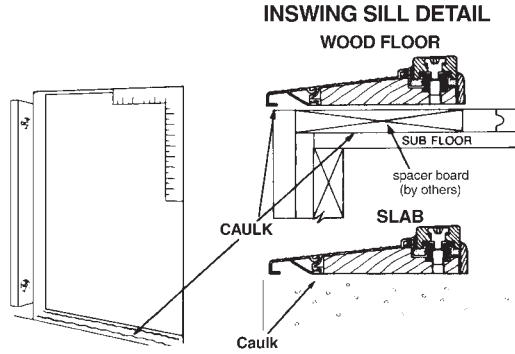

(FOR DOUBLE DOOR - SEE #8)

BROSCO suggests that a spacer board be attached to the bottom of the aluminum sill to provide proper clearance between bottom of door and finished floor.

**BROSCO strongly recommends the use of a Sill Pan Flashing - following the separate Sill Pan installation instructions.**

### 2. INSTALLATION BY TWO PEOPLE

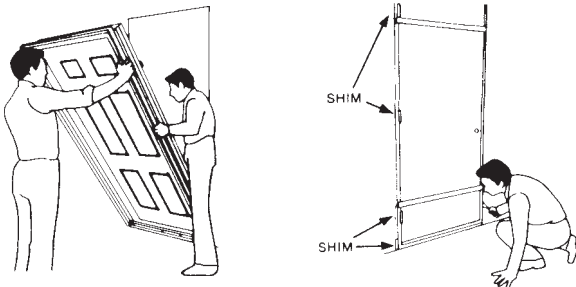

- Two people should place door unit in opening (sill first) and tilt unit into place. **DO NOT NAIL THROUGH CASING.**
- Solid shims should be placed between jamb and stud, behind all three hinges and at sill level, for proper anchoring of unit. Inside installer make sure unit and sill are firmly in place.

### 3. INSTALL UNIT SQUARE

**YOU MUST PLUMB UNIT - THEN NAIL HINGE JAMB FIRST!**

#### CORRECT MARGIN

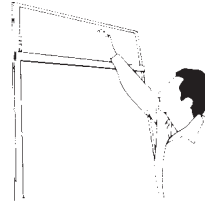

The unit is square when the head margin is even - any unit; single, double or sidelight. Inside installer check margin between top of door and head jamb. Shim unit as required until margin is even.

**NOW NAIL HINGE JAMB.**

**DO NOT REMOVE CROSS BRACES FROM UNIT UNTIL HINGE JAMB IS SECURED**

#### WRONG MARGIN



**PROBLEM:** Head margin wider at lock side than at hinge side.

**SOLUTION:** Additional shim at top lock side or bottom hinge side. (The entire unit must be moved toward hinge side at top or lock side at sill.)

### 4. ANCHOR HINGE JAMB FIRST

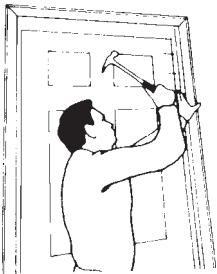

Outside installer nail hinge side jamb to stud using two 16 penny galvanized finish nails at each hinge point. Do not nail lock side at this time. Use framing square to check squareness of unit. **From this point, one person can complete installation.**

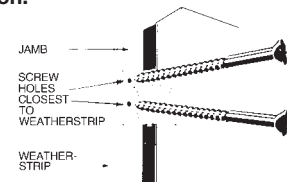

**Extra length screws (2 1/4" long) included for top hinge.**

Now, remove bracing and open door. Install the two extra length screws provided in two top hinge holes closest to the weatherstrip. These extra length screws prevent sag by anchoring unit through jamb and into stud.

### 5. ALIGN LOCK JAMB

**NEXT ADJUST LOCK SIDE BEFORE YOU NAIL IT!**

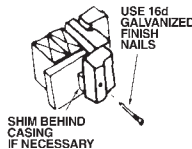

UNIT IS PLUMB WHEN LOCK JAMB FITS DOOR (do not plumb jamb with level). Adjust lock jamb in/out until it meets door evenly from top to bottom. Done correctly, there will be an even margin between face of door and the frame stop, top to sill. (From inside, face of door will be flush with edge of lock jamb.) **THIS STEP IS CRITICAL FOR PROPER SEAL OF WEATHERSTRIP.**



**PROBLEM:** Space between weatherstrip and face of door at top.

**SOLUTION:** Move bottom of frame out or top of frame in.



**PROBLEM:** Space between weatherstrip and face of door at bottom.

**SOLUTION:** Move bottom of frame in or top of frame out.

## 6. NAIL LOCK JAMB

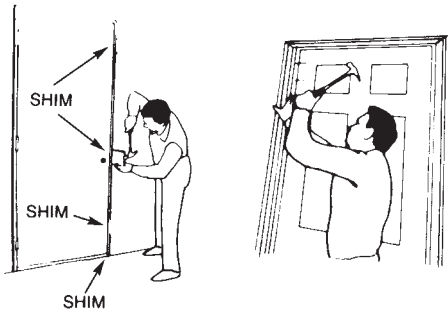

Shim lock jamb to stud at four points and nail jamb using 16 penny galvanized finished nails.

CHECK TO SEE THAT FRAME IS STILL PLUMB AND WAS NOT BOWED BY NAILING TO STUDS.

## 7. NAIL CASING

### FINISH NAILING EXTERIOR CASING

NAIL HEAD AND SIDE JAMB EXTERIOR CASING TIGHT FROM OUTSIDE WITH 16d GALVANIZED FINISH NAILS.

FLASHING (BY OTHERS) SHOULD BE APPLIED ON TOP OF HEAD CASING.

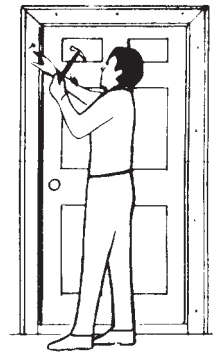

## 8. DOUBLE DOOR UNITS – ADDITIONAL STEP

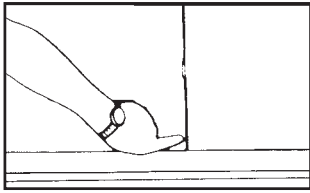

1. Make sure that both doors are even across the bottom, and across the top. If they are not, the unit is not installed square. Move top or bottom of the unit to align doors.



2. Nail inactive door jamb only and then adjust the active door jamb in or out until the door fits the "T" astragal from top to bottom before nailing.

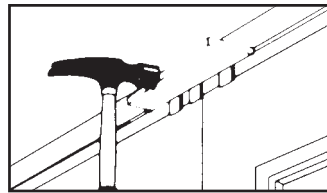

3. Shim the head jamb to provide an even margin between the top of the doors and the head jamb and then nail solid.  
NOTE: Caulk and install long screw (provided) in center of sill. Do not over-tighten and bow sill.

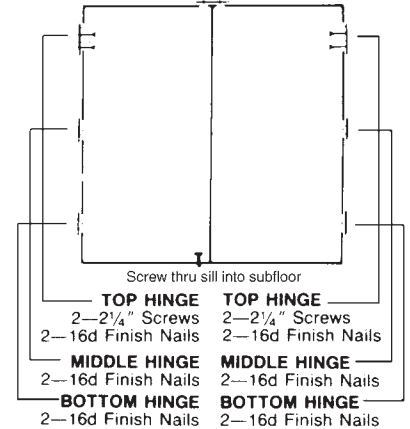

## 9. SIDELIGHT UNITS – ADDITIONAL STEPS

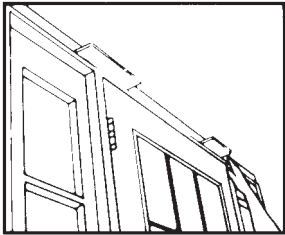

1. Shim and nail the head jamb solid at two points with 16d galvanized finish nails.

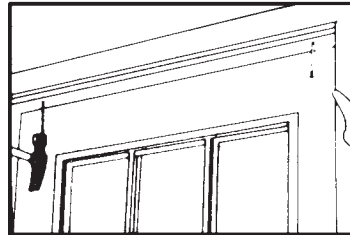

2. Shim the door jamb, if required, on the lock side so that the margin between the door and jamb is even from top to bottom before applying the interior trim.

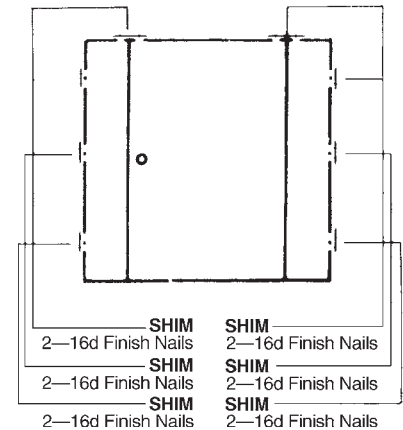

## OVERHANG PROTECTION

The protection of your door is a major factor in its maintenance requirements and longevity. To adequately protect your door and extend its life, several factors must be considered. Door type, climate, exposure, color choice and the use of a storm door all have an affect on the durability of a door.

For best performance and to meet the manufacturer's warranty, any exterior door should be installed under an overhang or with sufficient protection. Adequate overhang depends on typical weather conditions of the area where the door is installed, but at the minimum means an overhang projecting a distance from the structure equal to one half the distance between the bottom of the door and the bottom of the overhang.

Climate	Direction Door Faces			
	North	South	East	West
Mild	$X = 1/2 Y$	$X = Y$	$X = 1/2 Y$	$X = Y$
Wet	$X = Y$	$X = Y$	$X = Y$	$X = Y$
Ocean	$X = 1/2 Y$	$X = Y$	$X = 1/2 Y$	$X = Y$

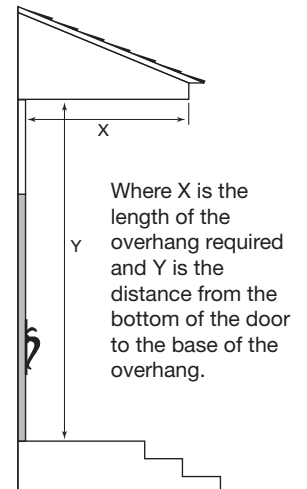

## FINISHING – PAINT DOOR, JAMB AND TRIM

### Prepare Entry Unit for Finish –

- Caulk under leading edge of sill on exterior.
- Putty nail heads and any other places needed.
- **DO NOT PAINT WEATHERSTRIP.**

### Finishing Recommendations -

- Do not apply finish in direct sunlight.
- Do not apply finish when dew is present or within an hour before dusk.

**REMEMBER – DO NOT CLOSE DOOR UNTIL FINISH IS THOROUGHLY DRY.**

### WOOD DOORS – PAINT OR STAIN

- Wood doors should be finished immediately after installation.
- It is best to stain or paint when temperatures are between 50° F & 90° F and humidity is below 85%.
- Surfaces must be clean and dry.
- Sand lightly and clean before first coat of finish (and between coats of polyurethane).
- Make certain surfaces are dry before apply additional coats.
- Use only high grade finish and follow manufacturer's instructions carefully.
- If you paint... Use 2 coats of primer, especially on top and all exposed edges followed by at least 2 coats of a high quality exterior latex paint on all surfaces. Be sure to lap paint on glass for proper seal.
- If you stain... Use semi-transparent stain or clear undercoat followed by a minimum of 2 coats exterior varnish or polyurethane including top and all exposed edges.
- **Note: Dark color finishes should be avoided on exterior surfaces of exterior doors. Manufacturer will not be responsible for failure of an improperly finished door.**

### FIBERGLASS DOORS – WOODGRAINED - GEL-TYPE STAIN

**DO NOT SAND DOOR.** Sanding Fiberglass may damage door surface. Wipe all door surfaces clean with a cloth dampened with mineral spirits and allow surface to dry. Surface must be free of dirt, grease or wax.

#### Stain Application –

- Stir Gel-Type Stain thoroughly before and during application. Follow manufacturer's instructions.
- Apply using a lint-free cloth in a circular motion, working the gel stain into the embossed grain pattern.  
Apply gel stain carefully where vertical and horizontal boards meet. Use stain cloth to smooth stain in the direction of the simulated grain. Use a soft-bristle brush to feather out lap marks.
- The longer the gel stain is left to set up before brushing, the darker the color will become. Apply additional coats of gel stain for darker shade. Brush out each section completely before moving on to the next section.
- Stain the door edges.

**Polyurethane Application –** Door must be completely dry before applying topcoat.

- **DO NOT SAND UNCOATED STAINED SURFACE.**
- Use only a high quality topcoat.
- Follow manufacturer's instructions. Apply only when temperatures are between 60° F & 90° F and the relative humidity is less than 50%. Use a foam brush or synthetic fiber brush. Do not use a roller.
- Flow polyurethane on in the direction of the simulated grain. Do not over-brush or trap air bubbles in the finish. Allow 4 hours drying time between coats. **APPLY AT LEAST 2 COATS ON ALL SIDES FOR EXTERIOR FIBERGLASS DOORS.** Additional coats will increase protection from the elements.
- Maintenance: Monitor the finish for a decrease in the gloss, which indicates a need to apply a new layer of topcoat.

### FIBERGLASS DOORS – SMOOTH SURFACE - PAINT

**DO NOT SAND DOOR.** Sanding Fiberglass may damage door surface. Wipe all door surfaces clean with a cloth dampened with mineral spirits and allow surface to dry. Surface must be free of dirt, grease or wax.

#### Paint Application –

- Clean surfaces with mineral spirits and let dry.
- Use only high grade finish and follow manufacturer's instructions carefully.
- Stir Paint thoroughly before and during application.
- It is best to stain or paint when temperatures are between 50° F & 90° F and humidity is below 85%.
- Apply 2 light coats of acrylic latex paint to all surfaces of door (including top and edges).
- Do not use an oil-based paint.

### STEEL DOORS – PAINT

Lightly scuff sand surfaces to improve adhesion and clean surfaces with mineral spirits.

#### Paint Application –

- Stir Paint thoroughly before and during application.
- It is best to paint when temperatures are between 50° F & 90° F and humidity is below 85%.
- Use only high grade finish and follow manufacturer's instructions carefully.
- Apply 2 light coats of acrylic latex paint to all surfaces of door (including top and edges).
- **Apply paint or stain to frame and trim (do not paint weatherstrip).**

### SILL THRESHOLD

1. Regular maintenance is recommended to retain appearance of HARDWOOD THRESHOLD...  
2 coats of linseed or teak oil applied annually is recommended.
2. If ADJUSTMENT is needed on aluminum sill...
  - a. Turn SCREWS slightly to change height of threshold.
3. Install corner seal weatherstrip to each side jamb just above the sill.



**The use of a Combination Storm/Screen door is recommended on exterior doorways to provide added protection against our rugged Northeast weather.**

Ask about BROSCO Craftsman Prefinishing for your next project.

Visit [brosco.com](http://brosco.com) today to take advantage of the following features –



- ◆ New Products
- ◆ Featured Products
- ◆ Book of Designs
- ◆ Literature
- ◆ Product Flyers
- ◆ Price Catalog
- ◆ Videos
- ◆ Dealer Locator
- ◆ E-Newsletter
- ◆ Installation Instructions
- ◆ Care & Finishing
- ◆ Warranty Information



### Show us the finished product –

We want to see how you have used our products in your projects. E-mail us pictures of your completed projects and we'll add them to our on-line Ideas Gallery – [pictures@brosco.com](mailto:pictures@brosco.com)